

2004-06-08

Fast Synchronization of Perpetual Grouping in Laminar Visual Cortical Circuits

<https://hdl.handle.net/2144/1926>

Downloaded from DSpace Repository, DSpace Institution's institutional repository

Fast synchronization of perceptual grouping in laminar

Arash Yazdanbakhsh and Stephen Grossberg

June, 2004

Technical Report CAS/CNS-2004-005

Permission to copy without fee all or part of this material is granted provided that: 1. The copies are not made or distributed for direct commercial advantage; 2. the report title, author, document number, and release date appear, and notice is given that copying is by permission of the BOSTON UNIVERSITY CENTER FOR ADAPTIVE SYSTEMS AND DEPARTMENT OF COGNITIVE AND NEURAL SYSTEMS. To copy otherwise, or to republish, requires a fee and / or special permission.

Copyright © 2004

Boston University Center for Adaptive Systems
and
Department of Cognitive and Neural Systems
677 Beacon Street
Boston, MA 02215

Fast Synchronization of Perceptual Grouping in Laminar Visual Cortical Circuits

Arash Yazdanbakhsh¹ and Stephen Grossberg²

Department of Cognitive and Neural Systems

and

Center for Adaptive Systems

Boston University

677 Beacon Street, Boston, MA 02215

Phone: 617-353-7858

Fax: 617-353-7755

Submitted: June 8, 2004

Technical Report CAS/CNS TR 2004-005

All correspondence should be addressed to

Professor Stephen Grossberg

Department of Cognitive and Neural Systems

Boston University

677 Beacon Street

Boston, MA 02215

Phone: 617-353-7858

Fax: 617-353-7755

Email: steve@bu.edu

¹ Supported in part by the ONR(N00014-01-1-0624)

² Supported in part by the AFOSR (F49620-01-1-0397) and the ONR(N00014-01-1-0624)
Correspondence concerning this article should be addressed to Stephen Grossberg, Department of Cognitive and Neural Systems, Boston University, 677 Beacon St. Boston, MA, 02215, Email: Steve@bu.edu

Abstract

Perceptual grouping is well-known to be a fundamental process during visual perception, notably grouping across scenic regions that do not receive contrastive visual inputs. Illusory contours are a classical example of such groupings. Recent psychophysical and neurophysiological evidence have shown that the grouping process can facilitate rapid synchronization of the cells that are bound together by a grouping, even when the grouping must be completed across regions that receive no contrastive inputs. Synchronous grouping can hereby bind together different object parts that may have become desynchronized due to a variety of factors, and can enhance the efficiency of cortical transmission. Neural models of perceptual grouping have clarified how such fast synchronization may occur by using bipole grouping cells, whose predicted properties have been supported by psychophysical, anatomical, and neurophysiological experiments. These models have not, however, incorporated some of the realistic constraints on which groupings in the brain are conditioned, notably the measured spatial extent of long-range interactions in layer 2/3 of a grouping network, and realistic synaptic and axonal signaling delays within and across cells in different cortical layers. This work addresses the question: Can long-range interactions that obey the bipole constraint achieve fast synchronization under realistic anatomical and neurophysiological constraints that initially desynchronize grouping signals? Can the cells that synchronize retain their analog sensitivity to changing input amplitudes? Can the grouping process complete and synchronize illusory contours across gaps in bottom-up inputs? Our simulations show that the answer to these questions is Yes.

KEY WORDS: perceptual grouping, binding problem, visual cortex, synchronization, illusory contours, bipole cell, horizontal connections, adaptive resonance, LAMINART model

Introduction: Fast Resynchronization of Desynchronized Cortical Activities

Neurophysiological recordings from visual cortex show that visual cortex can synchronize the activities of spatially separated cells, notably during perceptual grouping (e.g., Bullier, 2001; Diesmann et al., 1999; Eckhorn et al., 1988; Gray et al., 1989; Schmidt et al., 1997; Singer, 1999). Synchrony of firing activity may be within cortical columns, neighboring hypercolumns, distant hypercolumns and different cortical areas that represented the same stimulus properties like direction and orientation. Synchronized neural activity is also one of the proposed mechanisms that may lead to an enhanced, or resonant (Grossberg, 1976, 1980), firing rate (Diesmann et al., 1999; Engel et al., 2001; Fries et al., 2001; Hermann et al., 1995; Yazdanbakhsh et al., 2002). Gamma frequency synchronization, in particular, is suggested as a mechanism to enhance the impact on postsynaptic neurons and is found in visual cortex associated with perceptual grouping (Gray et al., 1989; Maldonado et al., 2000). Gamma frequency synchronization causes spikes to coincide within 10 ms (Fries et al., 2001). The time constant of cell membrane potentials varies within the range of 15 ± 10 ms, thereby allowing efficient temporal summation of spikes within a 10 ms time range, which is consistent with a pronounced firing rate if gamma synchronization of neural activity occurs.

Perhaps the earliest model to predict synchronous binding of distributed activations in visual cortex was that of Grossberg (1976, 1980), which focused on how bottom-up filtering and top-down attentional processes could cause fast synchronization through a feedback process called *adaptive resonance*. Since that time, a variety of models have attempted to simulate a synchronization property. Some neural models demonstrated synchronization using integrate-and-fire neurons in a feedforward network (Burkitt and Clark, 1999; Diesmann et al., 1999; Hermann et al., 1995; Yazdanbakhsh et al., 2002). They use inter-layer divergent and convergent connections to provide a shared or overlapping input to the cells of successive model layers to

correlate, and thus synchronize, activity of successive layer cells. These feedforward models do not, however, fit a wide variety of perceptual and brain data about the roles of perceptual grouping and attention in the cortical synchronization process.

Grossberg (1984) and Grossberg and Mingolla (1985a, 1985b) introduced a visual cortical model that simulated a wide range of data about perceptual grouping using long-range horizontal connections which obey a *bipole property*. This and subsequent work demonstrated how bipole grouping cells could help to complete boundary representations, including illusory contours, to form a grouped object representation. Many perceptual and neurobiological data about the role of horizontal long-range connections in perceptual grouping, notably cells that obey the bipole property, have since been reported. A notable example is the pioneering article of von der Heydt, Peterhans, and Baumgartner (1984) that directly demonstrated a bipole property through neurophysiological recordings in visual cortex while an animal inspected illusory contour stimuli. The anatomical study of Gilbert et al. (1989) reported long-range horizontal connections between the same functional units (i.e., tuned to the same orientation) in cat visual areas 17 and 18. Gilbert et al. (1989) concluded that a prominent and stereotypical feature of striate cortical circuitry is a plexus of long-range horizontal connections, running for 6-8 mm parallel to the cortical surface, which has a clustered distribution. Field et al. (1993) described psychophysical evidence of long-range cooperation that supported a bipole property. They called these cells and their interactions an *association field*. See Grossberg (1994, 1999), Grossberg, Mingolla, and Ross (1994), and Raizada and Grossberg (2003) for reviews of additional supportive data.

Long-range interactions are of importance if only because not all object parts are always present explicitly on the retinal image. The visual system has to process objects that are partially occluded by external barriers like tree branches, or internal ones like retinal vasculature and the blind spot. Perceptual grouping is a key process that can bridge these spatially disjoint parts of the same object representation, notably via illusory contours. Grossberg (1994) has clarified why some of these boundary completions look like visual illusions to us, whereas others look “real”.

Given the model’s initial success in interpreting perceptual grouping data, the question arose whether its neural responses to perceptually grouped inputs can rapidly synchronize. Grossberg and Somers (1991) and Grossberg and Grunewald (1997) tested the hypothesis that one role of synchronization is to rapidly resynchronize distributed inputs that belong to the same object. Such inputs may become desynchronized because different locations may process different luminances, contrasts, depths, and colors that may activate cells at different rates. In addition, previously processed objects may leave cells in different states of habituation that can also change their processing rates, as is illustrated by the phenomenon of visual persistence (e.g., Francis, Grossberg, and Mingolla, 1994). In order to process the entire object, without temporal leads and lags that could allow some object features to become bound to the wrong object when quickly viewing a series of objects through time, it was important to test that a bipole circuit (Figure 1a) could rapidly resynchronize desynchronized cell responses. Uncoupled cells that started desynchronized remained desynchronized (Figure 1b), but coupling the cells using bipole receptive fields enabled them to rapidly synchronize (Figure 1c). These bipole grouping cells were similar to the ones used by Grossberg and Mingolla (1985a, 1985b) and had no synaptic and neural conduction delays. Somers and Kopell (1993) mathematically analyzed why the circuit of Grossberg and Somers (1991) could rapidly resynchronize desynchronized activities. Grossberg and Somers (1991) also tested that other cell interactions could rapidly resynchronize desynchronized signals, notably through the type of bottom-up and top-down signal exchanges that had been predicted as part of how brain attention is linked to

processes of learning, as part of Adaptive Resonance Theory, or ART (Carpenter & Grossberg, 1991; Grossberg, 1976, 1980).

Since these results were derived, models of visual cortex have developed considerably to better understand how cortical circuits control a variety of perceptual functions, leading to a LAMINART model whose circuits correspond to identified cells in different cortical layers. This LAMINART model has explained and simulated data about perceptual grouping and attention (Grossberg, 1999; Grossberg, Mingolla, and Ross, 1997; Grossberg and Raizada, 2000; Raizada and Grossberg, 2001, 2003), stereopsis and 3D surface perception (Fang and Grossberg, 2004; Grossberg and Cao, 2004; Grossberg and Howe, 2003; Grossberg and Swaminathan, 2003), 3D figure-ground segregation (Grossberg and Yazdanbakhsh, 2003, 2004), and cortical development (Grossberg and Seitz, 2003; Grossberg and Williamson, 2001).

The LAMINART model represents a unification and elaboration of the pre-attentive perceptual grouping circuit of Grossberg and Mingolla (1985a, 1985b) and the attentive ART circuit of Grossberg (1976, 1980). In particular, the circuit that realizes the bipole property in the LAMINART model differs from that in the earlier Grossberg and Mingolla model, as do details about how the different cortical layers interact to achieve perceptual grouping and attention. Having thus been constrained by a variety of perceptual, developmental and cortical data, the question remains whether the more realistic LAMINART model can rapidly synchronize. This article demonstrates that fast resynchronization still occurs in such a laminar cortical circuit when realistic synaptic and axonal delays are included. Aspects of these results were briefly reported in Yazdanbakhsh and Grossberg (2003a, 2003b).

A New Way to Compute: A Synthesis of Feedforward, Feedback, Digital, Analog, Synchrony, Grouping, Attention, Learning, Separability, Choice, and Speed

The LAMINART model brought into focus several new problems and proposed solutions thereof about the dynamics of cortical processing. As noted below, key properties of this model depend upon the existence of *balanced* excitatory and inhibitory signals in different cortical layers. In particular, a balance between excitation and inhibition is needed in the bipole circuit in layer 2/3 to ensure that perceptual groupings can form inwardly between pairs or greater numbers of inducers, but not outwardly from a single inducer. Likewise, a balance between excitation and inhibition is required in the on-center of a circuit from layer 6-to-4 that can provide excitatory modulation of cell activities in layer 4, but not fire them fully. This latter circuit plays an important role in attention and in the pre-attentive selection of a correct perceptual grouping in response to a complicated scene. Grossberg and Williamson (2001) proposed that such balanced circuits are needed for the cortex to develop and learn in a stable way, and simulated how such balanced connections could grow during cortical development.

On the other hand, balanced excitatory and inhibitory connections have also been used to explain the observed variability in the number and temporal distribution of spikes emitted by cortical neurons. Several model studies have shown how balanced excitation and inhibition can produce the highly variable interspike intervals that are found in cortical data (Shadlen and Newsome, 1998; van Vreeswijk and Sompolinsky, 1998). Given the LAMINART model proposal that such variability may reflect mechanisms that are needed to ensure stable development and learning by cortical circuits—that is, “stability implies variability”—the cortex is faced with the difficult problem that variable spikes are quite inefficient in driving responses from cortical neurons. The present results illustrate how these balanced excitatory and inhibitory connections can work together overcome the inefficiency of intermittent spiking by

resynchronizing desynchronized signals that belong to the same object, and thereby ensuring that the cortex processes them efficiently.

The LAMINART model embodies a novel way to compute in several other senses. It represents a new type of hybrid between feedforward and feedback computing, and also between digital and analog computing (Grossberg, 2004) for processing perceptual groupings as well as other types of distributed data. These properties go beyond the types of Bayesian formulations that are so popular today. The LAMINART model predicts that they allow the fast but stable self-organization that is characteristic of cortical development and life-long learning.

In particular, when an unambiguous scene is processed, the LAMINART model can quickly group the scene in a fast feedforward sweep of activation that passes directly through layer 4 to 2/3 and then on to layers 4 to 2/3 in subsequent cortical areas. This property clarifies how recognition can be so fast in response to unambiguous scenes; e.g., Thorpe et al. (1996). On the other hand, if there are multiple possible groupings in a scene, say in response to a complex textured scene, then competition among these possibilities due to inhibitory interactions in layers 4 and 2/3 can cause all cell activities to become smaller. This happens because the competitive circuits in the model are *self-normalizing*; that is, they tend to conserve the total activity of the circuit. This self-normalizing property is related to the ability of the shunting on-center off-surround networks that realize these competitive circuits to process input contrasts over a large dynamic range without saturation (Douglas et al., 1995; Grossberg, 1973, 1980; Heeger, 1992). In other words, these self-normalizing circuits carry out a type of real-time probability theory in which the amplitude of cell activity covaries with the certainty of the network's selection, or decision, about a grouping. Amplitude, in turn, is translated into processing speed. Low activation greatly slows down the feedforward processing in the circuit because it takes longer for cell activities to exceed output thresholds and to activate subsequent cells above threshold.

In the model, network uncertainty is resolved through feedback: Weakly active layer 2/3 grouping cells feed back signals to layers 6-then-4-then-2/3 to close a cortical feedback loop that rapidly contrast enhances and amplifies the winning grouping. As the winner is selected, and weaker groupings are suppressed, its cells become more active, hence can again rapidly send the cortical decision to subsequent processing stages. In summary, the LAMINART circuit behaves like a real-time probabilistic decision circuit that operates in a fast feedforward mode when there is little uncertainty, and automatically switches to a slower feedback mode when there is uncertainty. Feedback selects a winning decision that enables the circuit to speed up again. In all, activation amplitude and processing speed both increase with certainty. The large activation amplitude of a winning grouping is facilitated by the synchronization that occurs as the winning grouping is selected.

The LAMINART circuit also embodies a novel kind of hybrid computing that simultaneously realizes the stability of digital computing and the sensitivity of analog computing. This is true because the feedback loop between layers 2/3-6-4-2/3 that selects or confirms a winning grouping has the property of *analog coherence* (Grossberg, 1999; Grossberg, Mingolla, and Ross, 1997; Grossberg and Raizada, 2000); namely, this feedback loop can synchronously store a winning grouping without losing analog sensitivity to amplitude differences in the input pattern. The coherence that is derived from synchronous storage in the feedback loop provides the stability of digital computing, while preserving the sensitivity of analog computation.

A final property of note in a LAMINART circuit concerns its ability to stabilize development and learning using the *intracortical* feedback loop between layers 2/3-6-4-2/3 by selecting cells that fire together to wire together. Thus, the same intracortical decision circuit is predicted to help stabilize development in the infant and learning throughout life, as well as to

select winning groupings in the adult (Grossberg, 1999). Thus, properties of perceptual grouping in the adult are predicted to be constrained by the requirements of stable development in the infant. This intracortical circuit can work even before *intercortical* attentional feedback can develop to also stabilize cortical development and learning.

An early prediction of ART was that top-down attention can modulate the learning process through a competitive matching process (Grossberg, 1976, 1980), and later modeling studies refined this prediction to assert that the top-down matching circuit is realized by a modulatory on-center off-surround network, as described above. A great deal of perceptual and brain data have accumulated in support of this hypothesis; see Grossberg (2004) and Raizada and Grossberg (2003) for reviews of these data, including the popular “biased competition” phrase for this process.

The LAMINART model thus predicts that both pre-attentive grouping and top-down attention share the same modulatory on-center off-surround decision circuit from layer 6-to-4. This sharing by grouping and attention of the same decision circuit enables the model to explain and simulate data concerning how attention can selectively activate an entire object by propagating along its boundary representation (Grossberg and Raizada, 2000; Roelfsema et al., 1998). This property of the LAMINART model also implies another prediction; namely, intracortical feedback ensures that a “pre-attentive grouping is its own attentional prime” and can thereby stabilize its own development and learning. This prediction implies that, although attention is often needed for efficient learning to occur, learning can also occur without conscious attention if a pre-attentive grouping can “resonate,” in particular synchronize, for a sufficiently long time using its intracortical 2/3-6-4-2/3 feedback circuit. Seitz and Watanabe (2003) have recently reported data that are consistent with this prediction.

Cortical Grouping by the LAMINART Model

This section reviews the basic architecture of LAMINART by describing how it incorporates physiologically and anatomically supported connections between layers of visual cortex. Here we give just enough detail to make the article self-contained. As Figure 2a shows, the input from LGN directly excites layers 4 and 6 of V1. Layer 6 also directly excites layer 4 cells and indirectly inhibits them through inhibitory interneurons. Due to the balance between excitation and inhibition in the on-center of the circuit from layer 6 to 4, the excitatory effect of layer 6 on 4 is modulatory (Grossberg, 1999; Grossberg and Raizada, 2000), whereas the off-surround can be strongly suppressive (Stratford et al., 1996; Callaway, 1998). This modulatory on-center off-surround network is part of the pre-attentive and attentive competitive decision circuit that was described in the previous section. Due to this modulatory property, input from layer 6 to layer 4, by itself, is predicted to be unable to fire the formation of perceptual groupings, such as illusory contours, in layer 2/3. The presence of inhibitory interneurons in this circuit (Ahmed et al., 1997; Tamas et al., 1998) adds synaptic and conduction delays that can desynchronize neural activity. These delays are implemented in the present simulations in addition to the rest of the LAMINART grouping circuit to test if their presence prevents synchronization of neural activity.

As Figure 2b shows, layer 4 cells excite layer 6 cells as well as 2/3 excitatory pyramidal cells (Fitzpatrick et al., 1985; Callaway and Wiser, 1996). The intracortical feedback between layers 6 and 4 has been predicted to play an important role in models of cortical development, notably in the development of the cortical map of interleaved orientation columns and ocular dominance columns; e.g., Grossberg and Seitz (2003), Grossberg and Williamson, (2001), and Olson and Grossberg (1998). The layer 2/3 cells that are activated by layer 4 have long-range horizontal axons to integrate perceptual grouping signals along coaxial and co-oriented receptive field axes (Bosking et al., 1997; Schmidt et al., 1997). These axons also excite

layer 2/3 short-range inhibitory interneurons (McGuire et al., 1991; Hirsch and Gilbert, 1991), which in turn inhibit the excitatory cells of layer 2/3. The balance between horizontal excitation and inhibition in this circuit results in the bipole property whereby perceptual groupings can form inwardly in response to pairs, or greater numbers, of approximately coaxial and co-oriented inputs (Tucker and Katz, 2003a, 2003b), but not outwardly in response to individual inputs. Layer 2/3 excitatory cells, in turn, excite layer 6 cells (Figure 2b). This is the intracortical decision circuit, discussed above, that helps to stabilize cortical development and to select a winning grouping.

Finally, Figure 2c indicates that one pathway whereby top-down intercortical attention can influence the circuit is also via the 6-to-4 decision circuit. This property indicates how attention can influence which perceptual grouping is chosen; in particular, how attention can selectively activate an entire object representation.

Comparison of the Grossberg and Somers (1991) network (Figure 1a) with the LAMINART network (Figure 2) shows that, in the former, the loop between bipole cells and fast excitatory cells crosses two synapses. However, in the LAMINART circuit, if we consider the indirect inhibition from layer 6 to 4, the number of synapses within a loop is four, each with a delay. In addition, the positive feedback from layer 6 to 4 is modulatory in the LAMINART circuit, but could actively fire cells in the Grossberg and Somers network. Finally, the LAMINART model layer 2/3 bipole grouping cells includes multiple delays whereby outwardly propagating excitatory signals along long-range horizontal connections excite their neighbors, as well as inhibitory interneurons, in order to realize the bipole property; see the Appendix. None of these delays were considered by Grossberg and Somers (1991), who simulated an earlier version of the bipole cell model with zero delays.

LAMINART Synchronization without Bipole Grouping

As in the Grossberg and Somers (1991) methodology, we first test the situation where no bipole grouping cells are involved and then add them to evaluate their effect on synchronization. These simulations show that, given a constant input pattern from the LGN (Figure 2a), fast synchronization occurs even without bipole connections (Figure 3). This is in contrast with the decoupled case that was considered by Grossberg and Somers (1991) in Figure 1b, where the oscillations remained uncorrelated in time. This novel finding can be interpreted in terms of divergence and convergence of axonal branches of layer 6 that excite the inhibitory interneurons of layer 4 (Figure 2a). In this regard, some networks with inhibitory connections within their circuit have previously been shown to exhibit a synchronizing tendency (Brunel, 2000; Burkitt and Clark, 1999; van Vreeswijk et al., 1994; Yazdanbakhsh et al., 2002). However, this result cannot be taken for granted, because inhibitory connections within other circuits can also exhibit a desynchronizing tendency (Campbell et al., 1999; Grossberg, Pribe, and Cohen, 1997; Pribe, Grossberg, and Cohen, 1997). The standard deviation of the oscillation phase slightly increases from ~1ms (right after fast synchronization) to ~2 ms (after a few oscillations). This slight increase also occurred in the delay-less circuit of Grossberg and Somers (1991).

Figure 4 shows that this synchronization is primarily due to inhibitory interactions by demonstrating that the effect of an input from layer 6 to layer 4, by itself, can only modulate the excitability of layer 4 cells.

From a functional perspective, the synchronization that occurs without bipole grouping may be interpreted as a result of the feedback interactions which enable the cortical map and cortical receptive fields to develop, even before eye opening, and before there is significant perceptual role for perceptual grouping to play; cf., Olson and Grossberg (1998).

What is the Contribution of Bipole Grouping Cells?

Figure 5 summarizes the fast synchronization that occurs when cells in layer 2/3 start out with desynchronized activities and bipole grouping cells are also included within the circuit, but there are no bottom-up inputs from LGN. This synchronization is due to recurrent interactions among the layer 2/3 cells themselves, since feedback to layer 2/3 via the feedback loop 2/3-6-4-2/3 is merely modulatory. This simulation shows that synchronization is not due merely to the erosion of initial values in response to a sustained external input, because there is no external input in this case. This result differs from that in Grossberg and Somers (1991) in several ways: The LAMINART model allows groupings to form in a fast feedforward sweep within layer 2/3, which the earlier grouping model did not, and also allows grouping signals to recurrently propagate within layer 2/3, whereas in the earlier grouping model, signals propagated between cortical layers.

Figure 6a and 6b show that fast synchronization of desynchronized initial activities can also occur when bipole grouping cells exist in response to a sustained LGN input, both for real and illusory contours, respectively. The result for illusory contours (middle panel of 6b) shows that the model can complete boundaries across partially occluded regions of an object. Figure 6c shows that illusory contour completion does not occur when there are no bipole cells in the circuit. Compared to Figure 3, two quantitative differences can be observed in Figure 6: First, the absolute value of the standard deviation of oscillation phase is less; and second, the slope of the slight increase through time in the standard deviation is less.

Figure 7 shows that the synchronization process preserves analog sensitivity to the amplitude of LGN inputs, both for real and illusory contours. In other words, the LAMINART model proposes a solution of the binding problem that preserves the property of *analog coherence* (Grossberg, 1999): Its selection process can coherently and synchronously bind together spatially distributed activities, indeed can complete across them, without a loss of analog sensitivity to input amplitude. The simulations show that these context-sensitive representations can be synchronized throughout all the layers of cortex, despite the many additional delays that occur across the layers and within the bipole grouping process.

Summary

This article tests the possibility of fast resynchronization and its stability within laminar visual cortical circuits with realistic axonal and synaptic delays. The simulations show that laminar organization, even without bipole grouping, can support fast synchronization. This synchronization is due to the anatomical divergence and convergence within inter-layer inhibitory interactions from layer 6 to 4, and the recurrent feedback between these layers, which can generate synchrony on a millisecond time scale. Adding bipole grouping has three effects: Completing boundaries between occluded parts of an object, decreasing the absolute value of the standard deviation of the oscillation phase, and providing more stability of the fast resynchronization process. The result that previously activated bipole grouping cells can support fast synchronization without bottom-up inputs shows that synchronization is not just a matter of forgetting initial values due to large external inputs. It also raises the question of how groupings are shut off. This question has been investigated in terms of properties of visual persistence, whose habituated mechanisms are fully consistent with the simulations reported herein (Francis and Grossberg, 1996; Francis, Grossberg, and Mingolla, 1994).

If there is a rapid change of the stimulus, say as an object moves, there may not be enough time for oscillations to develop. In this case, fast resynchronization can still help the

system to compute coherent data from different aspects of the object without necessarily generating a sustained oscillation. This fact shows the importance of *fast* synchronization of spatially disparate object parts. The simulations show that this fast resynchronization can take place on the order of a fraction of one oscillation period (consider the fanning-in of the uncorrelated oscillations of layer 4 excitatory and layer 6 cells). Therefore, even there is not enough time for LAMINART to oscillate, or the network parameters do not generate oscillations, fast resynchronization is there to group neural activities in the appropriate time frame. The model also clarifies how it can sometimes take much longer for a final grouping to develop when there are many possible interpretations of a scene, or the bottom-up inputs are sufficiently sparse and ambiguous to require significant boundary completion before object recognition is possible.

APPENDIX

In the present simulations, 40 cells per model cortical layer are considered. Cells in layers 6, 4, and 2/3 are simulated. These cells are organized in a ring architecture to avoid spurious boundary effects; see also Grossberg and Somers (1991). Layers 6 and 4 inhibitory and excitatory cell initial activities were drawn from a uniform random distribution to mimic the role of desynchronized activity. The *LGN* input (L_i) of all cells is constant in time and is equal to 5.

Layer 6 cell activities, $X_i^{(6)}(t)$, are governed by the following membrane, or shunting equation (Grossberg, 1973; Hodgkin and Huxley, 1952):

$$\frac{dX_i^{(6)}(t)}{dt} = -X_i^{(6)}(t) + (B - X_i^{(6)}(t)) \left(L_i + X_i^{(4)}(t - d_{sy}) + \alpha X_i^{(2/3)}(t - d_{sy}) \right), \quad (1)$$

where $X_i^{(4)}(t)$ and $X_i^{(2/3)}(t)$ are signals from the i th cell of layers 4 and 2/3 at time t , respectively. Term $-X_i^{(6)}(t)$ on the right hand side of (1) says that activity $X_i^{(6)}(t)$ decays at rate -1. Parameter $B = 1$ in the shunting term $B - X_i^{(6)}(t)$ is the upper limit of activation in response to the summed input $\left(L_i + X_i^{(4)}(t - d_{sy}) + \alpha X_i^{(2/3)}(t - d_{sy}) \right)$ on the right hand side of (1). Parameter d_{sy} denotes the synaptic delay and is 1ms (Kandel and Schwartz, 1985). Parameter α defines the connection strength of the layer 2/3 excitatory cell to the corresponding layer 6 cell and equals 7 in the simulation of Figure 6 and zero in Figure 3. By increasing it from zero to 7, the oscillation jitter decreases and the synchrony stabilizes in time. As Figure 2b shows, layer 4 and 2/3 cells connect corresponding layer 6 cells by crossing one synapse. Therefore in (1), the activity of inputs from layer 4, $X_i^{(4)}(t - d_{sy})$, and from layer 2/3, $X_i^{(2/3)}(t - d_{sy})$, are one synaptic delay, d_{sy} , behind the activity, $X_i^{(6)}(t)$, of the corresponding layer 6 cell in time.

The activity, $Y_i^{(4)}(t)$, of inhibitory interneurons of layer 4 cells obeys:

$$\frac{dY_i^{(4)}(t)}{dt} = -Y_i^{(4)}(t) + \gamma X_i^{(6)}(t - d_{sy}) - Y_i^{(4)}(t) \sum_{j \in -M}^{+M} W_j Y_{i+j}^{(4)}(t - |j| d_{Ax} - d_{sy}). \quad (2)$$

On the right hand side of (2), the activity of layer 6 cells, $X_i^{(6)}(t - d_{sy})$, provide the excitatory input to layer 4 inhibitory interneurons. Term $-Y_i^{(4)}(t) \sum_{j \in -M}^{+M} W_j Y_{i+j}^{(4)}(t - |j| d_{Ax} - d_{sy})$ on the right-hand side of (2) implements recurrent shunting inhibition among inhibitory interneurons, $Y_{i+j}^{(4)}(t - |j| d_{Ax} - d_{sy})$, which are connected via a Gaussian kernel W_j :

$$W_j = \frac{1}{2\pi\sigma^2} \exp\left(-0.5(j/\sigma)^2\right). \quad (3)$$

The inhibition ensures that excitation from layer 6 to 4 has a modulatory effect on layer 4, and also tends to normalize the total activity of the inhibitory interneuronal population. This equation includes two types of delays: synaptic, d_{sy} , and axonal, d_{Ax} . All the recurrent interneuron inhibitions from layer 4, $Y_{i+j}^{(4)}(t - |j| d_{Ax} - d_{sy})$, are lagged by a constant synaptic delay, because there is one synaptic distance between layer 4 inhibitory interneurons which inhibit each other. Besides this constant synaptic delay, each $Y_{i+j}^{(4)}(t - |j| d_{Ax} - d_{sy})$ is delayed by axonal delays on the right hand side of (2). These axonal delays are scaled by $|j|$, the number of neighboring cells

between the input cell at location $(i+j)$, as in $Y_{i+j}^{(4)}$, and location (i) , where the layer 4 inhibitory interneuron, $Y_i^{(4)}$, gets its input. In other words, d_{Ax} is the axonal delay per axon length which connects two neighboring units. The axonal parameter d_{Ax} equals 2 ms/(one unit of neighboring offset). This axonal delay estimate used the conduction velocity 0.5 m/s of horizontal axonal connections (Bullier, 2001). Since one unit of horizontal positional shift, equivalent to one hypercolumn in spatial extent, is 1 mm, we find $0.001 \text{ m}/0.5 = 2 \text{ ms}$. Parameter $\sigma = 4$ and $\gamma = 0.6$.

Layer 4 cell activities, $X_i^{(4)}(t)$, obey the following membrane equation with the same parameter B as in (1):

$$\frac{dX_i^{(4)}(t)}{dt} = -X_i^{(4)}(t) + (B - X_i^{(4)}(t))(L_i + \eta^+ X_i^{(6)}(t - d_{Sy})) - X_i^{(4)}(t) \sum_{j \in -M}^{+M} W_j^- Y_{i+j}^{(4)}(t - |j| d_{Ax} - d_{Sy}). \quad (4)$$

The LGN provides the direct excitatory input, L_i , to the right hand side of (4). The excitatory input, $\eta^+ X_i^{(6)}(t - d_{Sy})$, from layer 6 to 4 has a modulatory effect on the activity of layer 4 cells, $X_i^{(4)}(t)$, that is, without, L_i , the balance of excitation from layer 6 and inhibition by inhibitory interneurons of layer 4, $Y_i^{(4)}(t - d_{Sy})$, just slightly increase the activity of layer 4 cells $X_i^{(4)}(t)$.

The shunting inhibitory term $-X_i^{(4)}(t) \sum_{j \in -M}^{+M} W_j^- Y_{i+j}^{(4)}(t - |j| d_{Ax} - d_{Sy})$ on the right hand side of (4) shows that corresponding layer 4 inhibitory interneurons $Y_{i+j}^{(4)}(t - |j| d_{Ax} - d_{Sy})$ with related synaptic and axonal delays (d_{Sy} and d_{Ax} respectively), inhibits the layer 4 cell activity $X_i^{(4)}(t)$. In (4), the lower limit for the activity of activity of $X_i^{(4)}(t)$ is zero (shunting property). Kernel W is linearly scaled by 0.67 to yield W^- . Parameter $\eta^+ = 0.15$.

The activity of layer 2/3 grouping cells, $X_i^{(2/3)}(t)$, is determined by:

$$\begin{aligned} \frac{dX_i^{(2/3)}(t)}{dt} = & -X_i^{(2/3)}(t) + (B - X_i^{(2/3)}(t))([X_i^{(4)}(t - d_{Sy})]^+ + \sum_{j \in -B}^{+B} (Q_j^{(2,L)} + Q_j^{(2,R)})[X_{i+j}^{(2/3)}(t - |j| d_{Ax} - d_{Sy})]^+) \\ & - Q^{Is} X_i^{(2/3)}(t)([Y_i^{(2/3,L)}(t - d_{Sy})]^+ + [Y_i^{(2/3,R)}(t - d_{Sy})]^+). \end{aligned} \quad (5)$$

Each layer 2/3 cell has excitatory connections with its left and right neighboring layer 2/3 cells through half-Gaussian kernels, $Q_j^{(2,L)}$ and $Q_j^{(2,R)}$. These kernels are defined as in (3) with the additional constraint that if $j > 0$, $Q_j^{(2,L)}$ equals zero and if $j < 0$, $Q_j^{(2,R)}$ equals zero. The standard deviation σ of the half-bipole kernel equals 6, which makes it broader than the inhibitory interneuronal kernel in layer 4, which is 4. Similarly these excitatory connections have one synaptic delay, d_{Sy} , and distance-dependent axonal delays, $|j| d_{Ax}$. As in (2), the summed delay is implemented by term $-|j| d_{Ax} - d_{Sy}$, in $X_{i+j}^{(2/3)}(t - |j| d_{Ax} - d_{Sy})^+$, on the right hand side of (5). The shunting inhibition to each cell of layer 2/3 is provided by the summed activity of left and right inhibitory interneurons of layer 2/3 ($Y_i^{(2/3,L)}$ and $Y_i^{(2/3,R)}$). However, this inhibition cross one synapse and faces a synaptic delay, d_{Sy} , to affect its target. This is

why $Y_i^{(2/3,L)}(t-d_{sy})$ and $Y_i^{(2/3,R)}(t-d_{sy})$ are summed on the right hand side of (5). Parameter Q^{ls} in (5) equals 1.7.

The layer 2/3 inhibitory interneuron activities, $Y_i^{(2/3,L/R)}(t)$, are determined by:

$$\frac{dY_i^{(2/3,L/R)}(t)}{dt} = -Y_i^{(2/3,L/R)}(t) + \sum_{j \in -M}^{+M} Q_j^{(2,L/R)} X_{i+j}^{(2/3)}(t - |j|d_{ax} - d_{sy}) - Q^{inh} Y_i^{(2/3,L/R)}(t) Y_i^{(2/3,R/L)}(t - d_{sy}). \quad (6)$$

The activity of excitatory cells in layer 2/3, $X^{2/3}$, are passed through the same half-Gaussian kernels, $Q_j^{(2,L/R)}$, which are defined as in (5). Depending on the offset index, j , the axonal delay, $|j|d_{ax}$, is implemented, the same way as in (5), accompanied by the fixed synaptic delay, d_{sy} . In the shunting inhibition term, $Q^{inh} Y_i^{(2/3,L/R)}(t) Y_i^{(2/3,R/L)}(t)$, the right/left inhibitory interneuron, $Y_i^{(2/3,R/L)}(t-d_{sy})$, inhibits the left/right inhibitory interneuron, $Y_i^{(2/3,L/R)}(t)$. Because this inhibition pass through one synapse, the former lags a d_{sy} behind the latter ($t-d_{sy}$ versus t). Parameter Q^{inh} equals 1.2.

Numerical integration was performed by the forward Euler method with the time step of $dt = 0.0002$ s.

The largest gap at which illusory contours form in V2, is 4.4 degree of visual angle (von der Heydt et al., 1984). The center of the stimulus in von der Heydt et al. (1984) was located 3 degrees of visual angle from the fixation point. The cortical magnification factor is

$\frac{K}{z+a}$ (Schwartz, 1977), where constant K equals 15 and constant a equals 0.5. Variable z represents the eccentricity and hence in our case equals 3° . Therefore, the magnification factor is 4.3 mm per degree. Hence a 4.4 degree largest gap spans 4.4 degrees times 4.3mm/degree, which equals approximately 19 mm across the V1 cortical surface. The width of a hypercolumn in V1 with both ocularities in macaque is ~1mm (Horton, 1984). However, von der Heydt et al. (1984), recorded from V2. Along the iso-polar direction, there is a ~1-to-1 scaling from V1 to V2. Along the iso-eccentricity direction, there is a 3-to-1 compression from V1 to V2 (Roe et al., 1995). Therefore, the axonal distance within V2 corresponding to that 19 mm in V1 is equal or less than 19 mm. We consider the maximum value (19 mm) to push the model to the limit to test its synchronization property. Using the Horton (1984) data, this ~19 mm is equivalent to ~19 hypercolumns, therefore, we set the spatial extent of half-Gaussians $Q_j^{(2,L)}$ and $Q_j^{(2,R)}$ equal to 9 to let each layer 2/3 cell get input from 9 cells to its left and right, which totals 19 connected cells (9+1+9).

REFERENCES

- Ahmed, B., Anderson, J. C., Martin, K. A. C., & Nelson, J. C. (1997). Map of the synapses onto layer 4 basket cells of the primary visual cortex of the cat. *Journal of Comparative Neurology*, 380, 230–242
- Bosking WH, Zhang Y, Schofield B, & Fitzpatrick D. (1997). Orientation selectivity and the arrangement of horizontal connections in tree shrew striate cortex. *Journal of Neuroscienc*, 7:2112-27
- Brunel N. (2001). Dynamics of sparsely connected networks of excitatory and inhibitory spiking neurons, *Journal of Computational Neuroscience*, 8:183-208
- Bullier J. (2001). Integrated model of visual processing, *Brain Research Review*, 36:96-107
- Burkitt AN, & Clark GM (1999). Analysis of integrate-and-fire neurons: synchronization of synaptic input and spike output, *Neural Computation*, 11: 871–901
- Callaway, E. M. (1998). Local circuits in primary visual cortex of the macaque monkey, *Annual Review of Neuroscience*, 21: 47–74
- Callaway, E. M., & Wiser, A. K. (1996). Contributions of individual layer 2-5 spiny neurons to local circuits in macaque primary visual cortex. *Visual Neuroscience*, 13: 907–922
- Campbell SR, Wang DL, & Jayaprakash C. (1999). Synchrony and desynchrony in integrate-and-fire oscillators, *Neural Computation*, 11: 1595-619
- Carpenter GA, & Grossberg S (1991). *Pattern Recognition by Self-Organizing Neural Networks*. Cambridge, MA: MIT Press
- Cohen M., & Grossberg S. & Cohen M. (1984). Neural dynamics of brightness perception: Features, boundaries, diffusion, and resonance. *Perception and Psychophysics*, 36: 428-456
- Diesmann M, Gewaltig M-O, & Aertsen A. (1999). Stable propagation of synchronous spiking in cortical neural networks, *Nature* 402: 529–532
- Douglas R. J., Koch C., Mahowald M., Martin K. A. C., & Suarez H. H. (1995). Recurrent excitation in neocortical circuits. *Science*, 269, 981–985
- Eckhorn R, Bauer R, Jordan W, Brosch M, Kruse W, Munk M, & Reitboeck HJ. (1988). Coherent oscillations: a mechanism of feature linking in the visual cortex? Multiple electrode and correlation analyses in the cat. *Biological Cybernetics*, 60:121-30.
- Engel, A. K., Fries, P., & Singer, W. (2001). Dynamic predictions, oscillations and synchrony in top-down processing. *Nature Reviews Neuroscience*, 2, 704 –716.
- Fang L. & Grossberg S. (2004). How are the surface lightnesses of complex stereograms assigned to the correct depths? *3rd annual meeting of Vision Sciences Society*, F13
- Field DJ, Hayes A, & Hess RF. (1993). Contour integration by the human visual system: evidence for a local "association field". *Vision Research* 33:173-93
- Fitzpatrick, D., Lund, J. S., & Blasdel, G. G. (1985). Intrinsic connections of macaque striate cortex: afferent and efferent connections of lamina 4C, *Journal of Neuroscience*: 5: 3329–3349
- Francis G, Grossberg S. (1996). Cortical dynamics of form and motion integration: persistence, apparent motion, and illusory contours, *Vision Research*, 36:149-73
- Francis G, Grossberg S, Mingolla E. (1994). Cortical dynamics of feature binding and reset: control of visual persistence, *Vision Research*, 34:1089-104
- Fries P, Reynolds JH, Rorie AE, & Desimone R. (2001). Modulation of oscillatory neuronal synchronization by selective visual attention, *Science*, 291:1560-3

- Gilbert CD & Wiesel TN. (1989). Columnar specificity of intrinsic horizontal and corticocortical connections in cat visual cortex. *Journal of Neuroscience*, 9:2432-42
- Gray CM, Konig P, Engel AK, & Singer W. (1989). Oscillatory responses in cat visual cortex exhibit inter-columnar synchronization which reflects global stimulus properties, *Nature* 338: 334-337
- Grossberg S. (1973). Contour enhancement, short-term memory, and constancies in reverberating neural networks. *Studies in Applied Mathematics*, 52, 217-257
- Grossberg, S. (1976). Adaptive pattern classification and universal recoding II: Feedback, expectation, olfaction, and illusions. *Biological Cybernetics*, 23, 187-202
- Grossberg, S. (1980). How does a brain build a cognitive code? *Psychological Review*, 87, 1-51
- Grossberg S. (1984). Outline of a theory of brightness, color, and form perception. In E. Degreef and J. van Buggenhout (Eds.), *Trends in mathematical psychology*, Amsterdam, North-Holland
- Grossberg S. (1994). 3-D vision and figure-ground separation by visual cortex, *Perception and Psychophysics*, 55:48-121
- Grossberg S. (1999). How does the cerebral cortex work? Learning, attention, and grouping by the laminar circuits of visual cortex. *Spatial Vision*, 12:163-85
- Grossberg S. (2004). How does the cerebral cortex work? Development, learning, attention, and 3D vision by laminar circuits of visual cortex. *Behavioral and Cognitive Neuroscience Reviews*, in press
- Grossberg S. & Cao Y. (2004). A laminar cortical model of stereopsis and 3D surface perception: Closure and da Vinci stereopsis, *4th annual meeting of Vision Sciences Society*, F30
- Grossberg, S. & Grunewald A. (1997). Cortical synchronization and perceptual framing. *Journal of Cognitive Neuroscience*, 9: 117-132.
- Grossberg S, Hwang S, & Mingolla E. (2002). Thalamocortical dynamics of the McCollough effect: boundary-surface alignment through perceptual learning. *Vision Research*, 42:1259-86
- Grossberg S. & Mingolla E. (1985a). Neural dynamics of form perception: Boundary completion, illusory Figures, and neon color spreading, *Psychological Review*, 92: 173-211.
- Grossberg S, & Mingolla E. (1985b). Neural dynamics of perceptual grouping: textures, boundaries, and emergent segmentations. *Perception and Psychophysics*, 38:141-71
- Grossberg S, Mingolla E, & Ross WD. (1997). Visual brain and visual perception: how does the cortex do perceptual grouping? *Trends in Neurosciences*, 20:106-11
- Grossberg, S., Pribe, C. & Cohen, M. (1997). Neural control of interlimb oscillations, I: Human bimanual coordination. *Biological Cybernetics*, 77: 131-140
- Grossberg S., & Raizada R.D.S. (2000). Contrast-sensitive perceptual grouping and object-based attention in the laminar circuits of primary visual cortex, *Vision Research*, 40: 1413-1432.
- Grossberg S., & Seitz A. (2003). Laminar development of receptive fields, maps and columns in visual cortex: the coordinating role of the subplate, *Cerebral Cortex*, 13: 852-63
- Grossberg S. & Somers D. (1991). Synchronized oscillations during cooperative feature linking in a cortical model of visual perception, *Neural Networks*, 4:453-466

- Grossberg, S. & Swaminathan, G. (2004). A laminar cortical model for 3D perception of slanted and curved surfaces and of 2D images: development, attention and bistability. *Vision Research*, 44:1147-87
- Grossberg S. & Williamson J.R. (2001) A neural model of how horizontal and interlaminar connections of visual cortex develop into adult circuits that carry out perceptual grouping and learning, *Cerebral Cortex*, 11: 37-58.
- Heeger, D.J. (1992). Normalization of cell responses in cat striate cortex. *Visual Neuroscience*, 9, 181–197
- Herrmann M, Hertz JA, & Prugel-Bennett A. (1995). Analysis of synfire chains. *Network, Computational Neural Systems* 6: 403–414
- Hirsch, J. A., & Gilbert, C. D. (1991). Synaptic physiology of horizontal connections in the cat's visual cortex, *Journal of Neuroscience*, 11: 1800–1809
- Hodgkin A. & Huxley A. (1952), A quantitative description of membrane current and its application to conduction and excitation in nerve, *Journal of Physiology*, 117: 500-44
- Horton JC. (1984). Cytochrome oxidase patches: a new cytoarchitectonic feature of monkey visual cortex. *Philos Trans R Soc Lond B Biol Sci*. Jan 17;304(1119):199-253.
- Kandel E. R. Principles of neural science, second edition, by Elsevier Science Publishing (1985)
- Maldonado PE, Friedman-Hill S, & Gray CM. (2000). Dynamics of striate cortical activity in the alert macaque: II. Fast time scale synchronization, *Cerebral Cortex*, 10:1117-31
- McGuire, B. A., Gilbert, C. D., Rivlin, P. K., & Wiesel, T. N. (1991). Targets of horizontal connections in macaque primary visual cortex, *Journal of Comparative Neurology*, 305: 370–392
- Moran J., Desimone R. (1985). Selective attention gates visual processing in the extrastriate cortex, *Science*, 229: 782-4.
- Motter BC. (1993). Focal attention produces spatially selective processing in visual cortical areas V1, V2, and V4 in the presence of competing stimuli, *Journal of Neurophysiology*, 70:909-19
- Niebur E, Koch C, & Rosin C. (1993). An oscillation-based model for the neuronal basis of attention, *Vision Research*, 33:2789-802
- Olson, S., & Grossberg, S. (1998). A neural network model for the development of simple and complex cell receptive fields within cortical maps of orientation and ocular dominance. *Neural Networks*, 11, 189–208
- Pribe, C., Grossberg, S. & Cohen, M. (1997). Neural control of interlimb oscillations, II: Biped and quadruped gaits and bifurcations. *Biological Cybernetics*, 77: 141-152.
- Raizada, RD & Grossberg, S. (2001). Context-sensitive bindings by the laminar circuits of V1 and V2: A unified model of perceptual grouping, attention, and orientation contrast. *Visual Cognition*, 8, 431-466
- Raizada RD, & Grossberg S. (2003). Towards a theory of the laminar architecture of cerebral cortex: computational clues from the visual system, *Cerebral Cortex*, 13: 100-13
- Reynolds JH, Chelazzi L, & Desimone R. (1999). Competitive mechanisms subserve attention in macaque areas V2 and V4, *Journal of Neuroscience*, 19: 1736-53
- Roe AW & Ts'o DY. (1995). Visual topography in primate V2: multiple representation across functional stripes, *Journal of Neuroscience*, 15: 3689-715
- Roelfsema PR, Engel AK, Konig P, & Singer W. (1997). Visuomotor integration is associated with zero time-lag synchronization among cortical areas, *Nature* 385:157-61

- Schmidt, K. E., Goebel, R., Lowel, S., & Singer, W. (1997). The perceptual grouping criterion of colinearity is reflected by anisotropies of connections in the primary visual cortex, *European Journal of Neuroscience*, 9: 1083–1089
- Seitz, A. & Watanabe, T. (2003). Is subliminal learning really passive? *Nature*, 422, 927
- Shadlen, M. N., & Newsome, W. T. (1998). The variable discharge of cortical neurons: implications for connectivity, computation, and information coding. *The Journal of Neuroscience*, 18, 3870–3896
- Shiple TF, & Kellman PJ. (1992). Strength of visual interpolation depends on the ratio of physically specified to total edge length, *Perception Psychophysics*, 52:97-106
- Singer, W. (1999). Neuronal synchrony: a versatile code for the definition of relations? *Neuron*, 24: 49-65
- Somers D, & Kopell N. (1993). Rapid synchronization through fast threshold modulation, *Biological Cybernetics*, 68:393-407
- Stratford, K. J., Tarczy-Hornoch, K., Martin, K. A. C., Bannister, N. J., & Jack, J. J. B. (1996). Excitatory synaptic inputs to spiny stellate cells in cat visual cortex, *Nature*, 382: 258–261
- Tamas, G., Somogyi, P., & Buhl, E. H. (1998). Differentially interconnected networks of GABAergic interneurons in the visual cortex of the cat. *Journal of Neuroscience*, 18: 4255–4270
- Thorpe, S., Fize, D., & Marlot, C. (1996). Speed of processing in the human visual system. *Nature*, 381: 520-522
- Tucker TR, & Katz LC. (2003a). Recruitment of local inhibitory networks by horizontal connections in layer 2/3 of ferret visual cortex, *Journal of Neurophysiology*, 89:501-12
- Tucker TR, & Katz LC. (2003b). Spatiotemporal patterns of excitation and inhibition evoked by the horizontal network in layer 2/3 of ferret visual cortex, *Journal of Neurophysiology*, 89: 488-500
- van Vreeswijk, C., Abbott, L. F., & Ermentrout, B. (1994). When inhibition not excitation synchronizes neural firing. *Journal of Computational Neuroscience*, 1: 313–321
- van Vreeswijk, C., & Sompolinsky, H. (1998). Chaotic balanced state in a model of cortical circuits. *Neural Computation*, 10, 1321–1371.
- von der Heydt, R., Peterhans, E., & Baumgartner, G. (1984). Illusory contours and cortical neuron responses. *Science*, 224, 1260–1262
- Yazdanbakhsh A, Babadi B, Rouhani S, Arabzadeh E, & Abbassian A. (2002). New attractor states for synchronous activity in synfire chains with excitatory and inhibitory coupling. *Biological Cybernetics*, 86: 367-78
- Yazdanbakhsh A. & Grossberg S. (2003a). How does perceptual grouping synchronize quickly under realistic neural constraints? 3rd annual meeting of Vision Sciences Society, TU16
- Yazdanbakhsh A. & Grossberg S. (2003b). Fast resynchronization during perceptual grouping by horizontal cortical connections, *Society for Neuroscience 33rd annual meeting*, 485.6

Figures

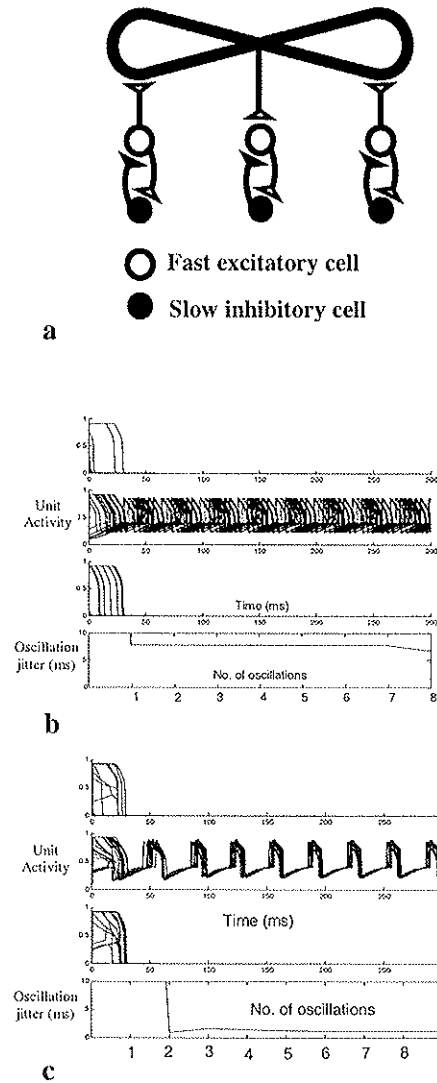

Figure 1. (a) The architecture used by Grossberg and Somers (1991). Fast excitatory cells are connected to slow inhibitory cells. This fast versus slow time constant can generate oscillations in suitable situations. (b) If the cells are not connected, then their initial out-of-phase activities remain out-of-phase through time with an approximately constrain oscillation jitter. (c) The out-of-phase activities rapidly synchronize, within a single oscillation cycle.

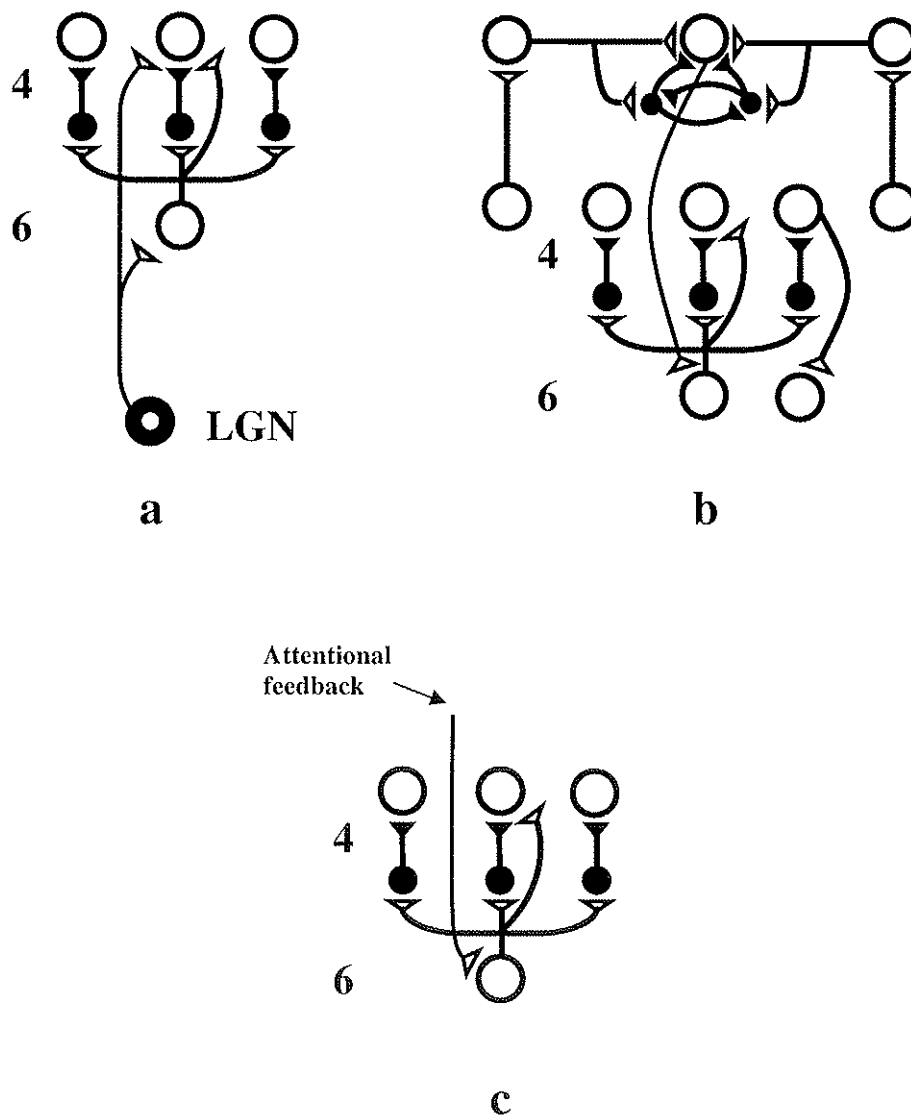

Figure 2. Key circuit features of the LAMINART model: **(a)** LGN excites both layers 6 and 4. Layer 6 indirectly inhibits layer 4 through the inhibitory interneurons. Therefore, the excitation from layer 6 to layer 4 is modulatory (direct excitation approximately balanced by indirect inhibition). **(b)** Layer 4 directly excites layer 6. This combined with the 6→4 inhibition can generate oscillations in a suitable parameter selection. Layer 4 also excites layer 2/3 cells, which have long horizontal axonal connections that also input the short-range inhibitory interneurons. The convergent excitation and inhibition results in the bipole property at target layer 2/3 cells. The cells in layer 2/3 send feedback to layer 6, which in turn subliminally excites layer 4 in the on-center and can strongly inhibit layer 4 cells through the off-surround. **(c)** Attention can also activate layer 6, and thereby have a modulatory effect on layer 4 that can help to select which grouping will win.

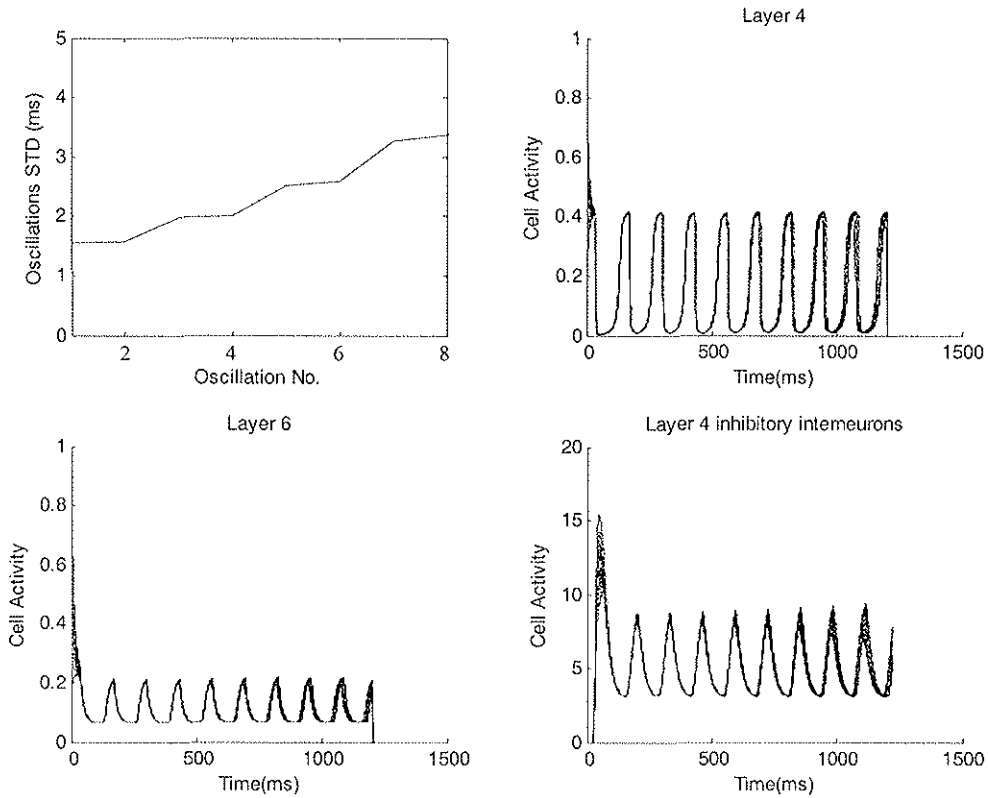

Figure 3. Activity of the different layers of the LAMINART circuit with no horizontal bipole connections within layer 2/3. Each panel is composed of superimposed oscillatory activity of all 40 cells. Layer 4 excitatory, inhibitory, and layer 6 cells activities are shown. The initial activity of the all layer units are randomly set (uniform random distribution between 0.2 and 0.8) to bring them into different phase relations. This random initiation can be seen easily by looking at the ordinate of layer 6 and 4 activity panels. Fast resynchronization funnels all of the activities together within a small fraction of one oscillation period and afterward they oscillate together. The jitter curve shows that the jitter after this funneling-in of curves is on the order of 1-2 milliseconds. There is also a slight increase of oscillation standard deviation in time (from ~1ms to ~2ms).

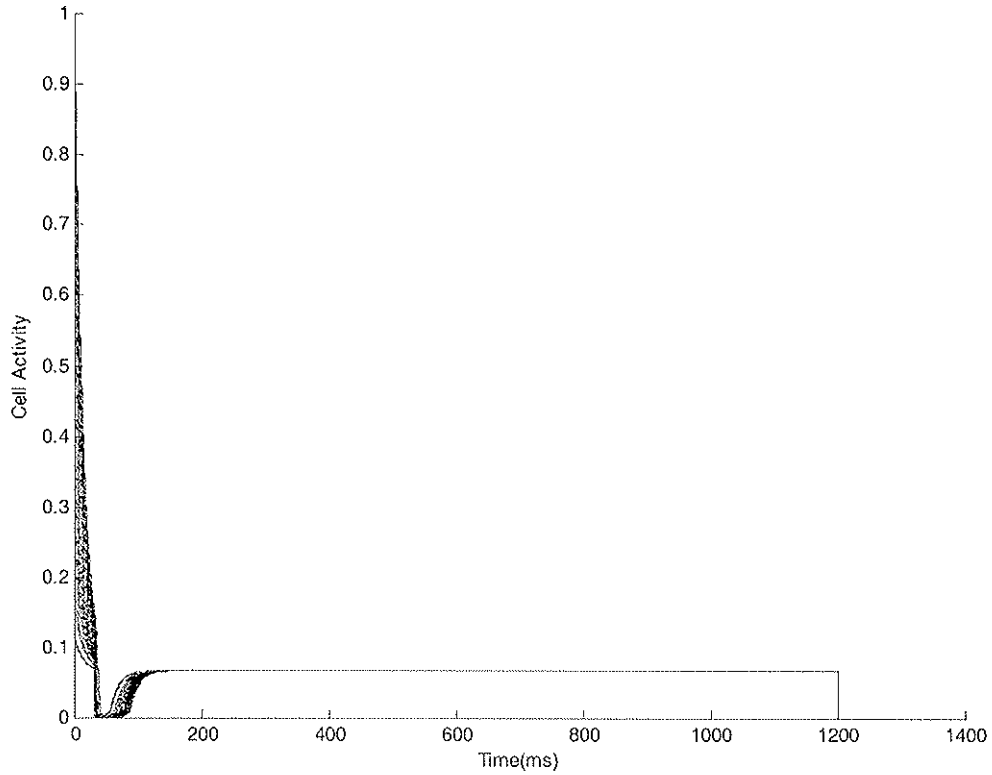

Figure 4. This simulation shows that inputs within the on-center of the network from layer 6 to layer 4 can only provide excitatory modulation of layer 4 cells, but cannot fire these cells strongly. Strong inhibition within the off-surround can also occur.

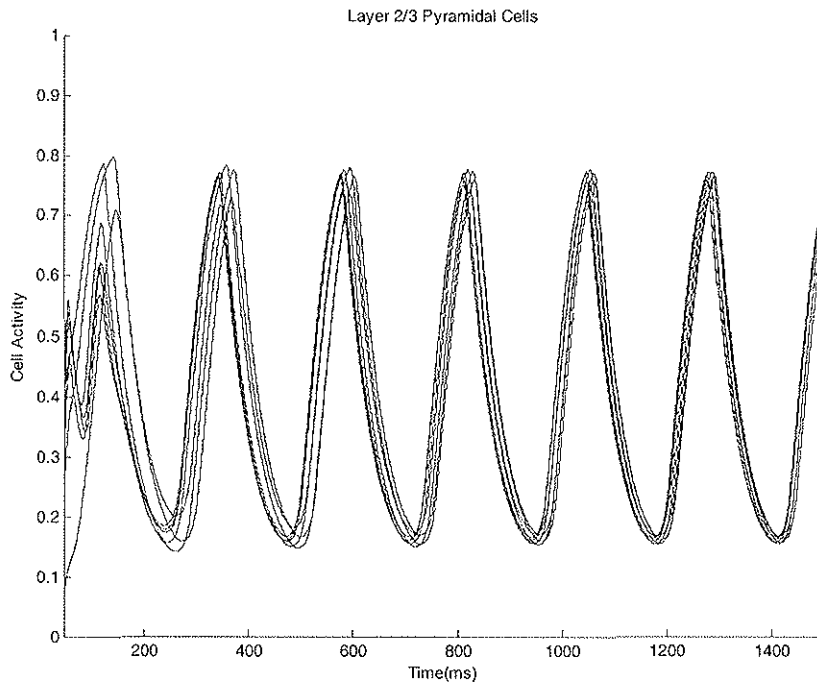

Figure 5. Here the bipole grouping cells are included, and are connected to layer 6, as shown in Figure 2b. The inputs from the LGN are zero, and the cells again start out with randomly set initial values. Fast synchronization again occurs, this time via the recurrent layer 2/3 long-range connections.

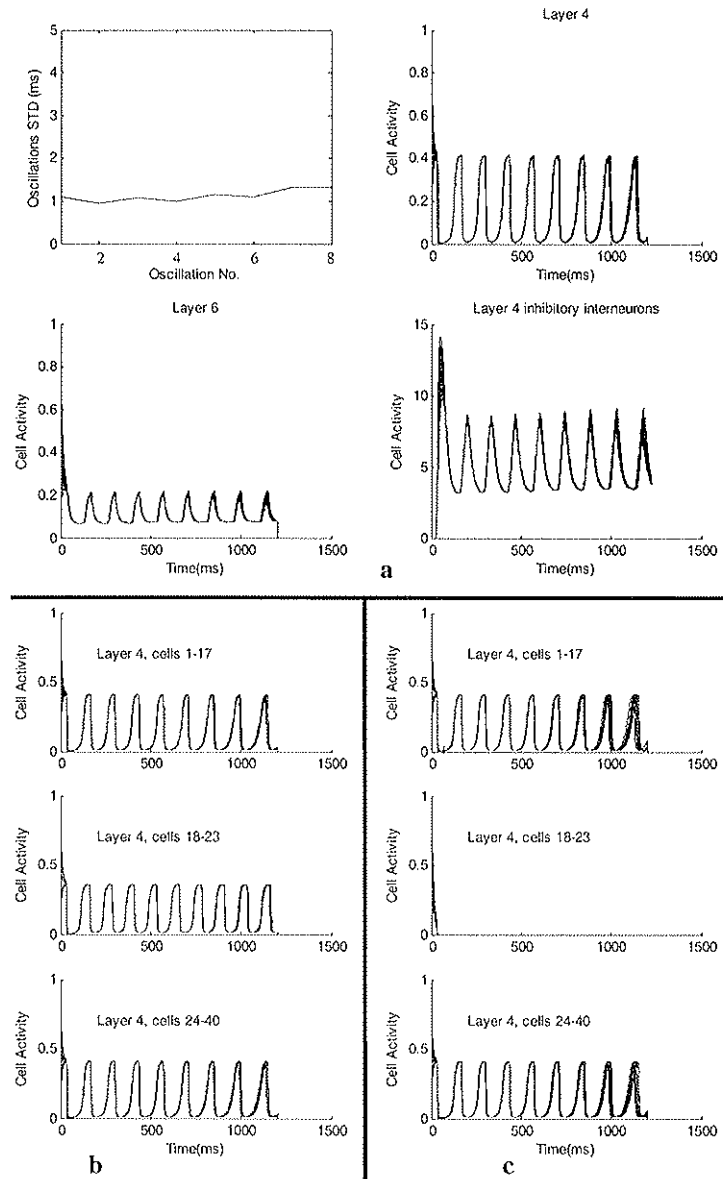

Figure 6. Here the bipole grouping cells are again included in (a) and (b), and constant inputs from the LGN are on. Again the network rapidly synchronizes, even though there are no LGN inputs to cells 18-23 of layers 6 and 4 in (b). Comparing the oscillation pattern with that in Figure 3 shows that, first, the absolute value of the oscillation jitter is less and, second, that the slight increase of the oscillation jitter is less too. (c) When there is no bottom-up LGN input to cells 18-23, and no bipole grouping cells, then the initial randomized activities of these cells fade away. The lateral cells (1-17 and 24-40), however, follow the same pattern of fast synchronized oscillation as in (a) and (b). Thus, the bipole grouping cells are needed to complete groupings across occluded image regions to form illusory contours.

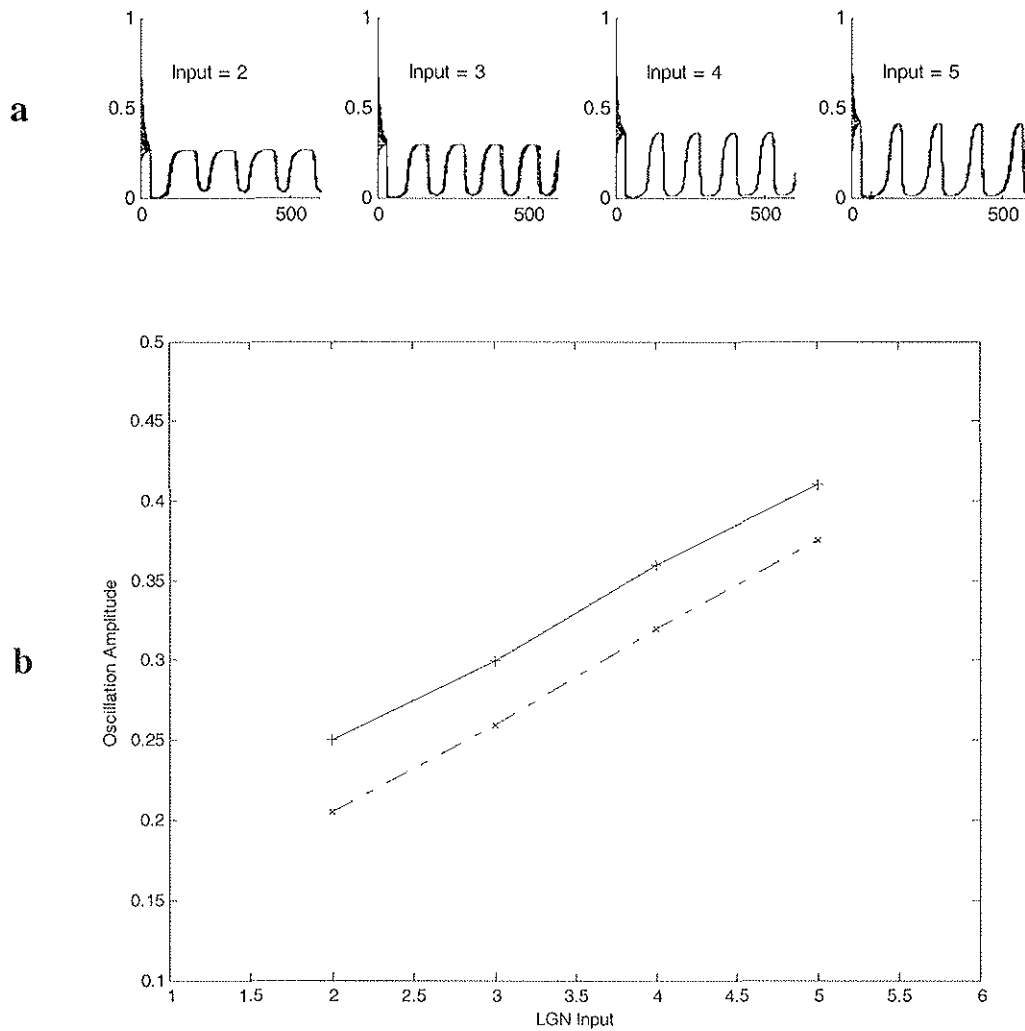

Figure 7. The activities of layer 2/3 cells retain their analog sensitivity to LGN input amplitude for both real and illusory contours. In **(a)**, oscillations for different LGN inputs are shown. In **(b)**, the solid curve shows the oscillation amplitude versus LGN input in the real contour case. The dotted curve shows the same in the illusory contour case.