

1926

The history, theory, operation, and uses of the electron tube

<https://hdl.handle.net/2144/5078>

Downloaded from DSpace Repository, DSpace Institution's institutional repository

BOSTON UNIVERSITY

GRADUATE SCHOOL

THESIS

THE HISTORY, THEORY, OPERATION, AND USES
OF THE
ELECTRON TUBE

Submitted by

Otis Edward Alley

(S.B., Boston University, 1924)

In partial fulfilment of requirements for
the degree of Master of Arts

1926

BOSTON UNIVERSITY
COLLEGE OF LIBERAL ARTS
LIBRARY

I
Upstairs
378.744
B0
A.M. 1926
al

OUTLINE

The History, Theory, Operation, and the Uses of the Electron Tube.

- I History of the Electron Tube
 - a Edison Effect
 - b Fleming Valve
 - c DeForrest Tube
- II General Theoretical Considerations
 - a Electron Theory
 - b Thermionic Emission
 - 1 The Edison Effect
 - 2 The Fleming Valve
- III Operation of the Electron Tube
 - a As a Rectifier
 - b As a Detector
 - c As an Amplifier
 - d As an Oscillator
 - e As a Modulator
- IV Other Uses of the Electron Tube
- V Summary

The History, Theory, Operation and Uses of the
Electron Tube.

Upstairs
378.744
B0
A.M. 1926
al

I History

The history of the electron tube does not date back very many years. The first important work with electron tubes was that of Edison in 1883. At this time he was experimenting with incandescent bulbs and with an arrangement like that shown below he noted that in the vacuum bulb V with a wire filament F heated by the battery B a current of electricity flowed from the filament F to the plate P. This current was detected by the instrument G called a galvanometer.

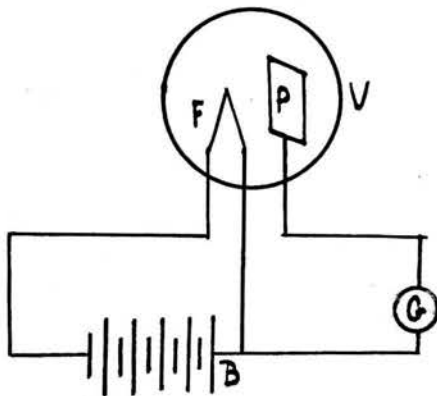

P=plate
F=filament
B=battery
G=galvanometer
V=vacuum bulb

Evidently Edison did not attempt to explain how the current of electricity could pass from the filament to the plate through a vacuum. Moreover he made no use of the discovery.

A little later, 1890-1896, J. A. Fleming investigated the Edison effect and he said that the small current from the filament to the plate was due to a negative carrier of electricity from the filament.

In 1899 Sir J. J. Thomson discovered this negative carrier of electricity as the electron and in 1903 Richardson developed his formula concerning the number of electrons given off by an incandescent wire.

J. A. Fleming made use of the Edison effect in 1904. He used a vacuum tube with a hot filament and cold plate for detecting wireless signals in place of a crystal detector. This tube was called the Fleming valve.

Dr. Lee DeForrest in 1907 improved the Fleming valve by adding a third part called the grid. This tube was called the audion and proved to be much more efficient than the previous detectors. From 1907 on, many types of audions were built all of which were fundamentally the same.

Dr. Irving Langmuir in 1912 began investigations of electron conduction in a high vacuum. He found that in a very high vacuum between a plate and filament the electron current varied as the three halves power of the voltage. In other words, Ohm's law did not hold. He also found that the electron current varied inversely as the square of the distance between the electrodes and that high voltages could be used provided proper precautions were taken to produce a high vacuum. Below is a curve showing the variation of voltage with current between a plate and filament. The voltage is plotted as abscissa and the current as ordinate. It may be noted that the current rises more rapidly than the voltage or, as before indicated, according to the three halves power of the voltage.

Variation of Voltage with Current in a Vacuum

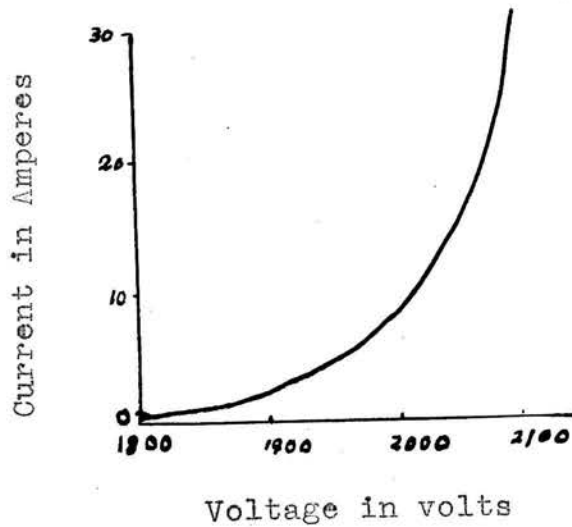

In 1921 the first commercial tube which could be operated by a dry cell was produced by the Westinghouse Electric and Manufacturing Company. This tube was called the WD-11. General Theoretical Considerations.

Before going into the operation of the electron tube it may be well to consider the general theory of electricity and electrons.

II

a. Electron Theory

An electron is a small particle of matter having a negative charge of electricity. Assuming the electron to be spherical, it has a radius of the order of 10^{-13} cm. and as far as has been determined all electrons are identical in every respect except velocity. The negative charge on the electron has the value of 4.774×10^{-10} c.g.s.e.s. units

An atom of matter in the neutral state may be considered as made up of a number of positive electric units and an equal number of negative units. An atom of matter negatively charged has an excess of electrons. If this same atom loses one electron it may become neutral or if it loses several electrons it may become positively charged.

Methods of separating electrons from atoms of matter.

Professor R. A. Millikan produced an oil spray from an atomizer and found that the electric charge on each particle was negative and equal to 3.77×10^{-10} e.s.u.

Metals when heated give off electrons. The beta particles given off by radioactive substances, particles given off by metals when acted on by X-rays or ultraviolet light, or negatively charged particles produced by ionization all have the same mass and charge as the electron.

b. Thermionic Emission.

According to the modern theory of current flow in metals the conduction of electricity in a wire consists in a movement of electrons. This movement exists when an electromotive force is applied to the wire. In the absence of this force the electrons are of course present in the wire, but their motion is not in any particular direction such as toward the positive terminal as in the case when a current is flowing. When no current is flowing, the motion of the electrons may be zigzag or vibratory. Some of the electrons near the surface of the metal may tend to leave it, but as soon as they do the metal becomes positively charged and draws the electrons back. As the temperature of the wire is made higher the velocity of the atoms and electrons becomes greater. Some of the electrons leave the surface of the metal, the distance from the surface before returning depending on the initial velocity which depends on the temperature.

Then suppose a positively charged body be placed near this electron emitting surface. The electrons will be attracted to this positively charged body and a current will flow. In the electron tube this body is called the plate, and the heated surface, which emits electrons, is called the filament.

When the positively charged plate is placed near the filament, as in the electron tube, many of the electrons are attracted to that plate as shown in the figure.

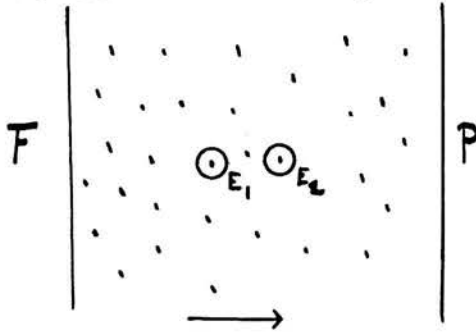

The motion of the electrons will depend on several things. First, with increase of voltage on the plate P, the attraction will be greater and more electrons will be drawn over. Also, on increasing the temperature of the filament F more electrons will be emitted. With the plate at constant voltage an electron such as E_2 being negative may repel E_1 . Therefore the electron E_1 will return to the filament, being drawn by the filament and also repelled by E_2 . The effect of E_2 on E_1 is called the space charge effect.

This explains the increase of current with increase of electron emission of the filament, the plate being at a constant voltage, up to a certain point and then remaining constant.

As the voltage of the plate is increased more electrons are drawn from the filament until nearly all the electrons emitted pass to the plate. The diagrams below show roughly the distribution at a given temperature, figure 2 being at the higher temperature. In both figures some of the electrons are moving away from the metal and others toward it.

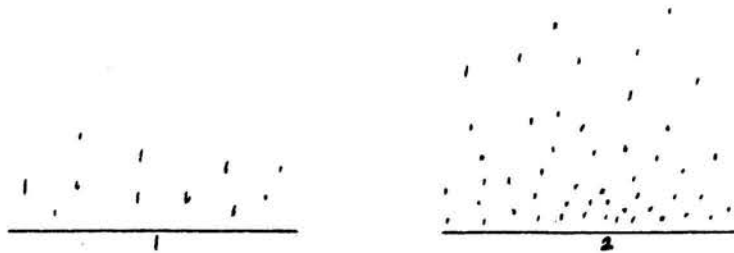

The distribution of electrons might be compared with the air around the earth. Near the earth the air is very dense, but as we go away from the earth the density of the air decreases.

Professor O.W. Richardson carried on the first quantitative work on electron emission, and found that with about a one per cent, change in the current through a wire, a twenty per cent change in the electron emission results. His formula is given below.

$$i = a T e^{-\frac{b}{T}}$$

i = emission of electrons

e = base of Napierian logarithm

T = absolute temperature

$$a = 23.6 \times 10^9$$

$$b = 52.5 \times 10^3$$

I The Edison Effect.

The theory of thermionic emission explains the Edison effect in this manner. In the figure we have a vacuum tube containing a filament which is connected to a battery. The current of electricity flowing through the wire causes electrons to be given off. As soon as electrons are given off, the wire becomes positively charged and tends to draw these electrons back. Moreover the electrons given off, having the same charge as those near the wire, tend to force those near the wire back. Finally a state of equilibrium will be reached when the same number of electrons are leaving the wire as are entering the wire at a given temperature.

F = filament

B = battery

R = variable resistance

V = vacuum tube

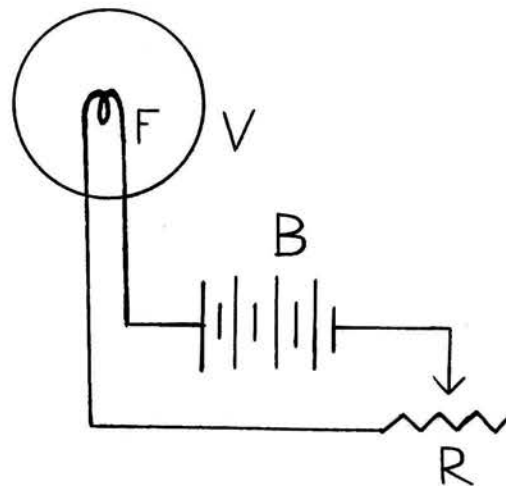

P=Plate

G=Galvanometer

B₂ B₁=Batteries

R=Variable resistance

F=Filament

V=Vacuum Tube

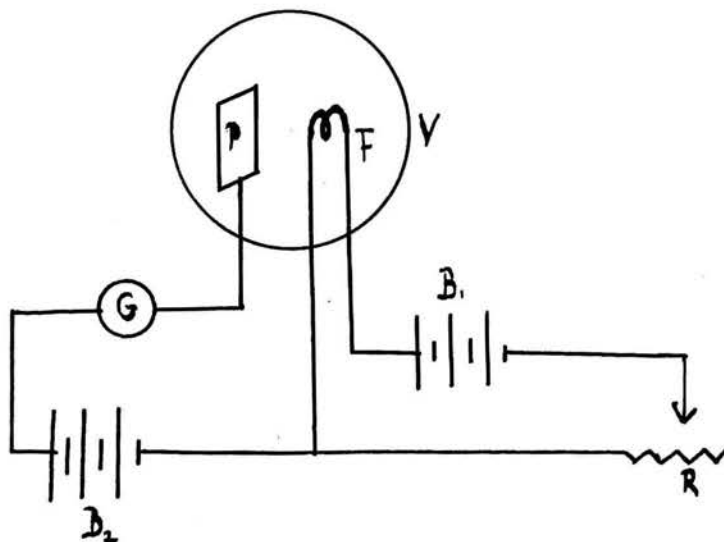

In order to show that electrons are given off by the heated wire insert a plate as shown in the figure above. In order to have any current flow through the galvanometer G the circuit from P to F must be completed. According to theory, if the plate P is positively charged by connecting it to the positive side of the battery, then electrons would be drawn from the filament to the plate and a current would flow. When connected in this manner a current does actually flow and is indicated by the galvanometer. If, however, P is connected to the negative side of the battery, it will repel the electrons from the filament and no current will flow. When connected in that manner the galvanometer shows no passage of current.

2. The Fleming Valve.

Fleming made use of the Edison effect in radio. A diagram is shown below where the Fleming valve acts as a detector.

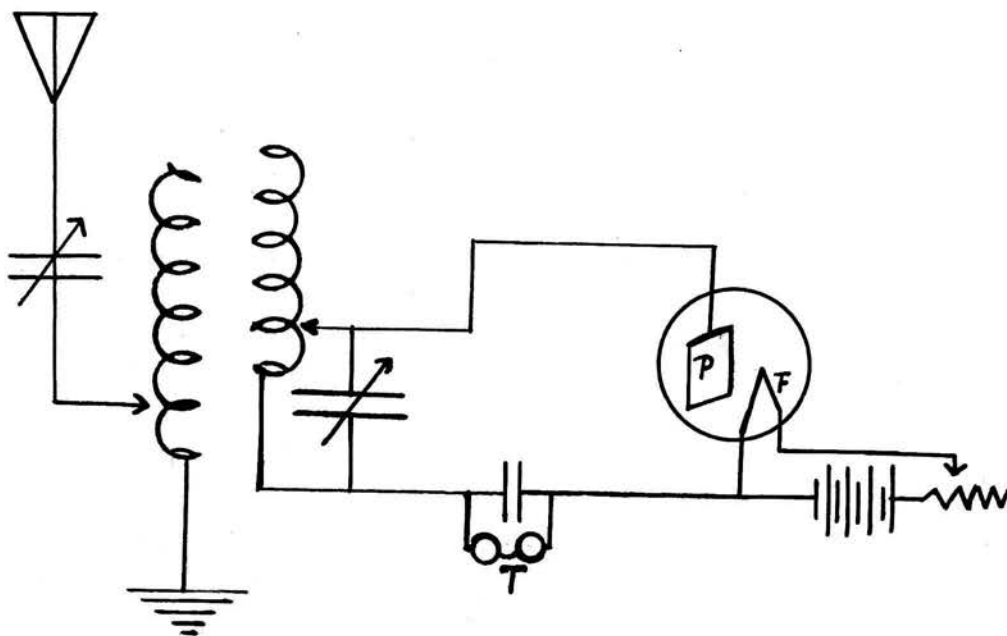

When the plate P is positive, current flows between the filament F and the plate. The condenser stores up energy and discharges the accumulation through T, the phones. This affects the diaphragm in the phones producing sound. When the plate is negative no current flows.

Applications of the Electron Tubes.

A. The Rectifier.

It is sometimes desirable to obtain a high voltage of direct current. This may be conveniently done by stepping up a 60 cycle alternating current supply with a transformer, and then rectifying this high voltage by means of an electron tube. The kind of tube necessary would be a two element tube similar to the Fleming Valve. This valve, when placed in the circuit would allow the current to pass in one direction only, since when the plate is positive, electrons will flow from the filament to the plate, but when the plate is negative the electrons from the filament will be repelled, and no current will flow. The resultant rectified power is unidirectional but not continuous, and condensers with inductances are used so as to store up charge during the high part of the cycle and deliver charge during the low part. This results in a fairly steady direct current at high voltage which was as desired. Below are given three diagrams. The first represents an ordinary alternating current which ranges from great positive value to great negative value. The second figure indicates the rectified current. As indicated by the diagram the current is positive all the time, but it fluctuates from high value to low value. The third figure represents the steady direct current as a result of the combination use of electron tube, condenser, and inductances.

Alternating Current

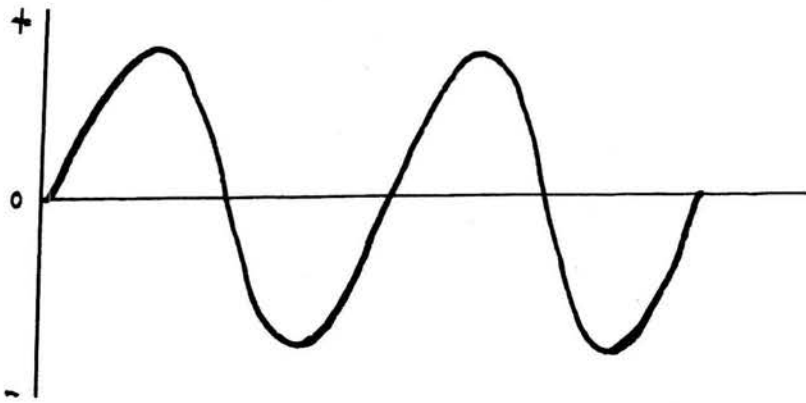

Pulsating Current

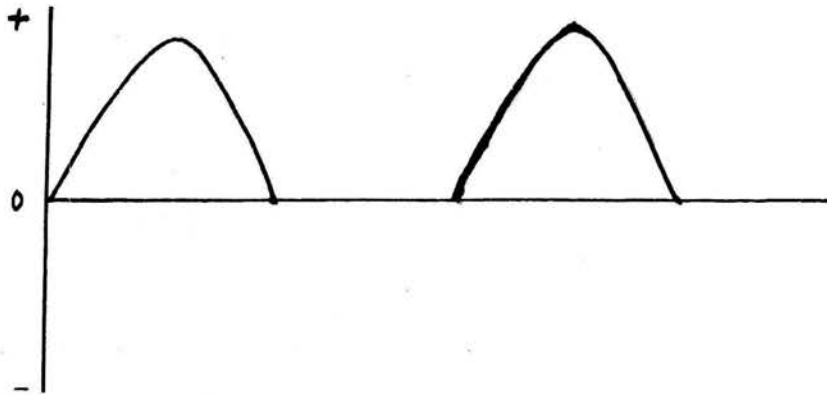

Steady Current

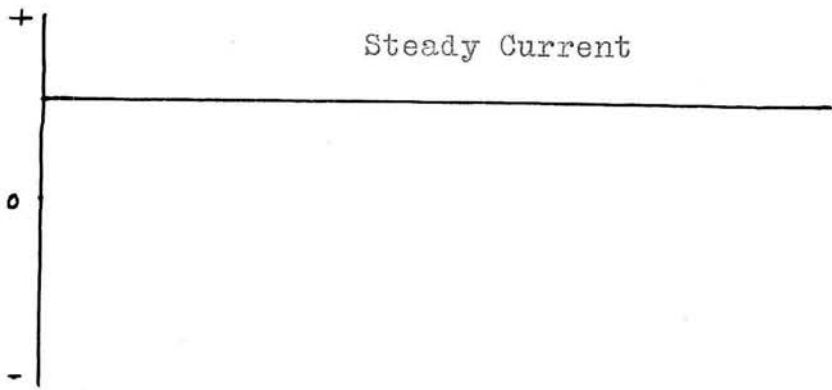

b. The Detector

The audion

The audion consists of three elements.

(1) a heated filament which acts as a source of electrons.

(2) a metal plate placed near the filament.

(3) a fine wire or perforated metal sheet called the "grid" which is placed between the filament and the plate. Thus in order to pass from the filament to the plate, the electrons must pass through the grid. A battery is connected across the filament and plate outside the tube so that an electron current may flow from the filament to the plate. The flow of this current will depend somewhat on the electrical condition of the grid. If the grid is negative for instance, it will repel the electrons from the filament, or in other words will not allow a flow of current. Suppose now, the grid to be positive. The electrons will be drawn toward it, and a current flows from the filament to the plate.

The space charge effect has been mentioned before in this paper. The influence of the grid on the space charge has much to do with the flow of electrons from the filament to the plate. Moreover, the grid is nearer the filament than the plate is, so a change of the electrical condition of the grid would have much more effect than a similar change of electrical condition of the plate. Below is a diagram of the audion.

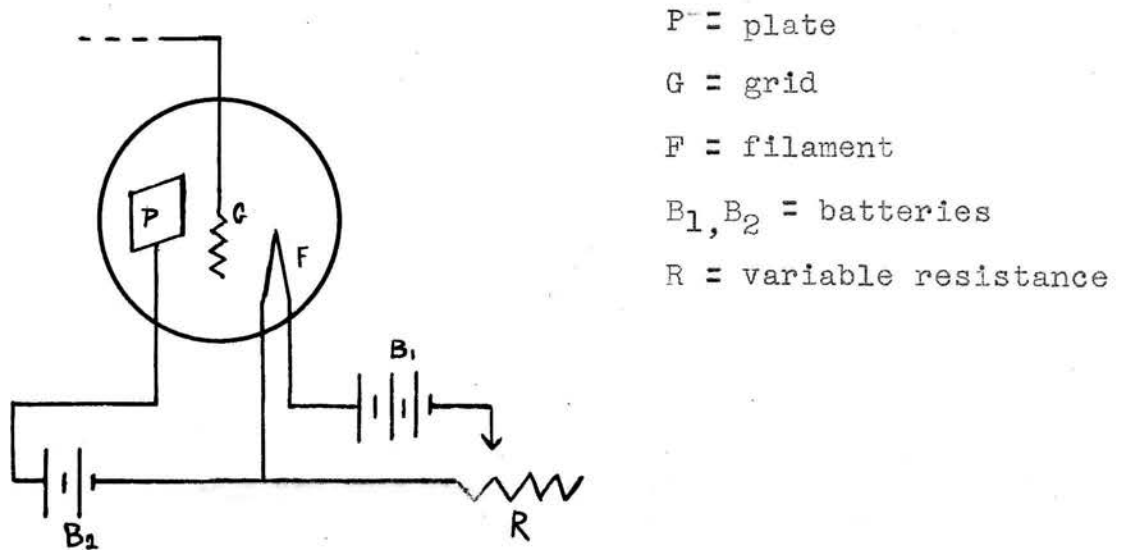

P = plate

G = grid

F = filament

B₁, B₂ = batteries

R = variable resistance

The Audion

The Audion as a Detector

The figure below shows the audion connected as a detector. The antenna is connected to the earth through a coil P. The electric waves which fall on the antenna oscillate back and forth through the coil P. This induces a current in the secondary coil S. and from there goes to the grid G. Now suppose the grid to be charged positively by the incoming oscillation. Then a current will flow from the filament to the plate and through the phones T. and battery B. Then when the grid becomes negative due to the incoming oscillation, no current flows because the electrons are repelled by a negative charge on the grid. Also the pulse sent through the phones will be great, as compared with the pulse sent along the antenna. This is because a slight change in the electrical condition of the grid produces great change in flow of current from the filament to the plate.

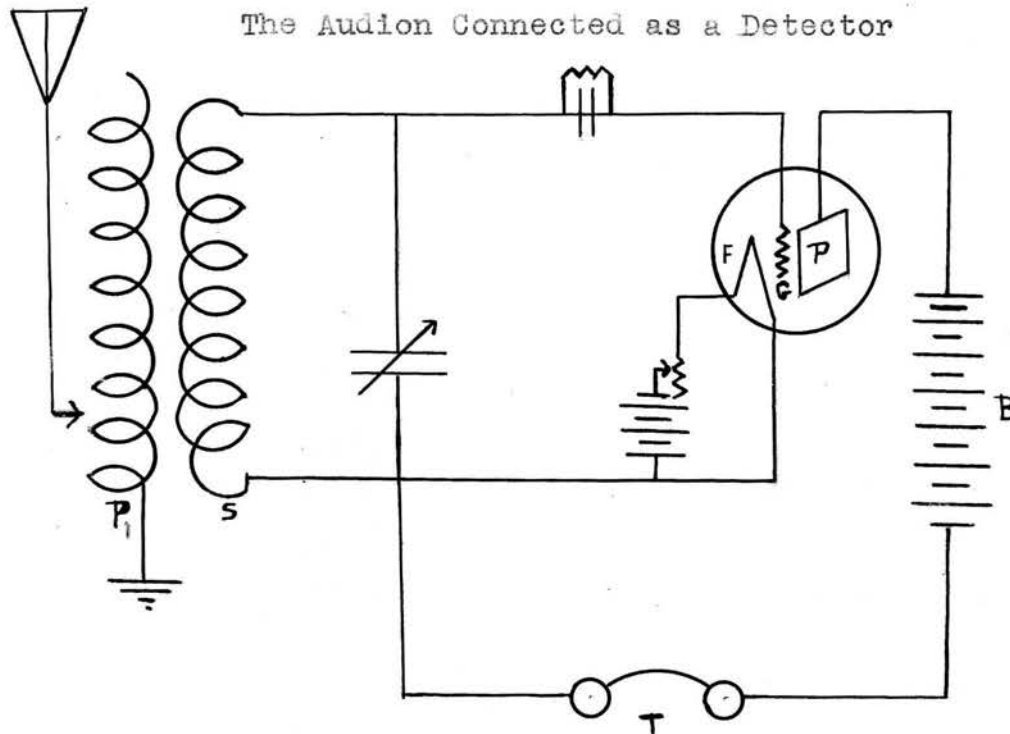

The electric oscillations received on the antenna are too rapid to produce sound with the diaphragm of a telephone. When these oscillations pass through the audion only the positive part of the oscillation is used, since the current can flow through the audion in one direction only. This results in a small pulse of current through the telephone in one direction. These pulses are continued and cause the diaphragm to vibrate, producing sound.

c. The Audion as an Amplifier

The voltage across the filament and plate is large. A very feeble change in the potential of the grid produces a strong pulse of current from the battery across the filament and plate. This property of the tube makes it useful as an amplifier in radio. The pulses thus detected and amplified by one tube may be sent to another tube and amplified still more in similar manner.

d. The Audion as an Oscillator.

Besides being used as a detector and amplifier, the audion is used as a generator of electric oscillations, or simply as an oscillator. The figure below indicates the connections necessary for the tube when used as such.

The Audion as an Oscillator

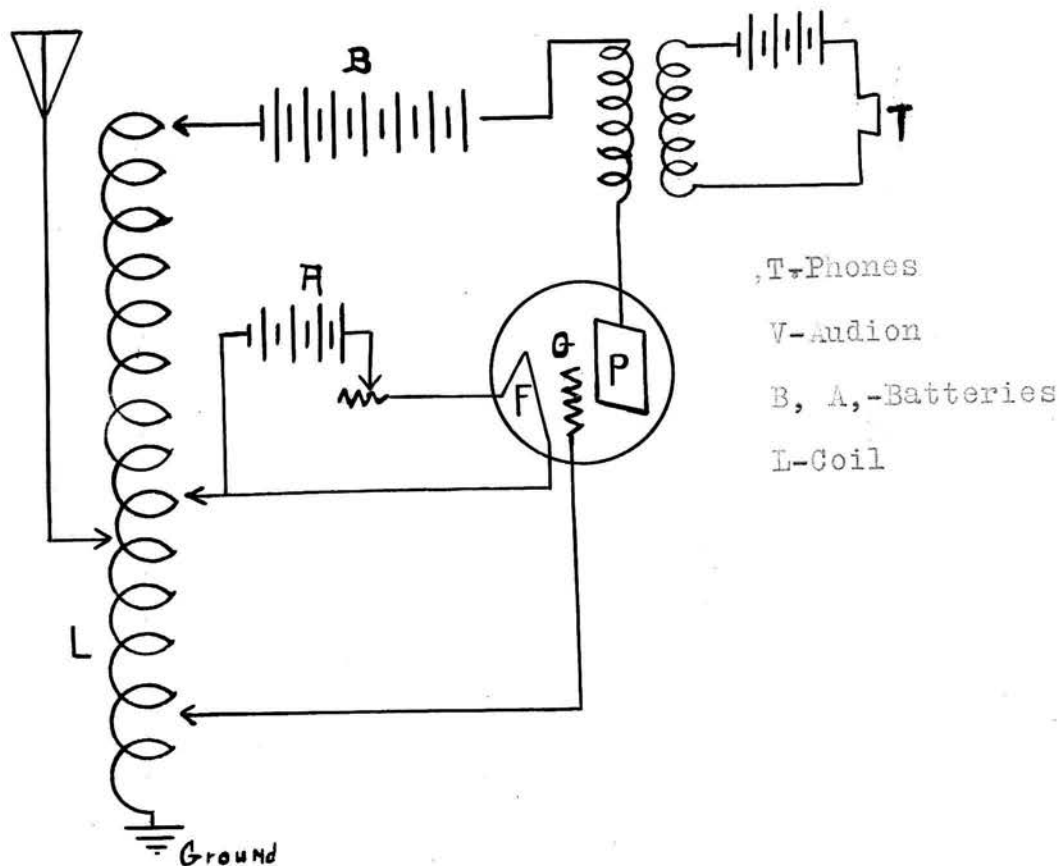

In order to understand how an oscillation may start suppose the circuit throwing on the A and B battery is closed. This would cause the grid to have a small charge from the B battery. If this charge is positive, then the current flows through the grid to the plate and then to the coil L. As the current passes through the coil L. it induces the current in an other part of the coil which is connected to the grid. This disturbs the potential of the grid still more, which produces still more current to the plate and from there through the coil. In the same way a fall in potential of the grid will result in a decrease of current in the coil. This condition is desirable for oscillations. Thus an upward impulse may be given to the coil, which results in a surging of the current up the antenna. This current drops down giving additional impulse through the grid which again starts the impulse upward.

This surging back and forth will continue to increase until the energy from the battery B is used up as fast as it is supplied by the resistance of the wire and by radiation of electric waves from the antenna.

e. The Audion as a Modulator

The oscillations just described have a wave formation which is continuous. These waves are called undamped waves and are shown below.

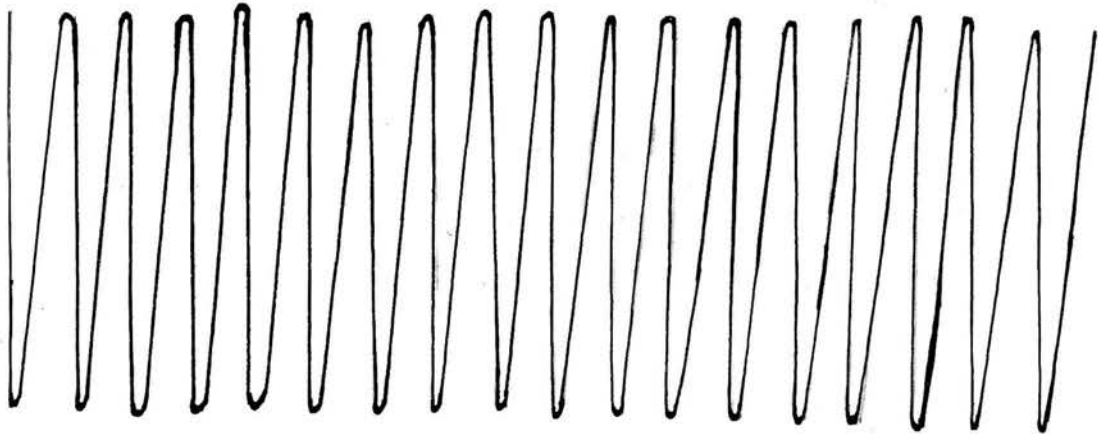

The waves above are oscillating too rapidly to set up vibration in the telephone diaphragm of a receiving set. When the diaphragm is set in vibration by a noise such as the voice at the sending set, corresponding changes of current are set up in the phone circuit. These changes are imposed on the high frequency wave of the oscillator and the waves combined are shown below.

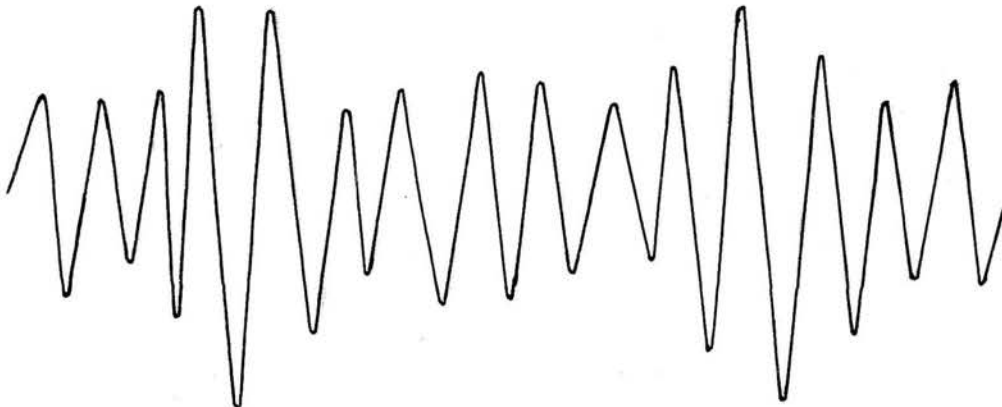

Then the detector of the receiving set cuts off the bottom part of the curve which results in variations in current as shown in the figure below. This resulting current affects the diaphragm of the phone producing sound.

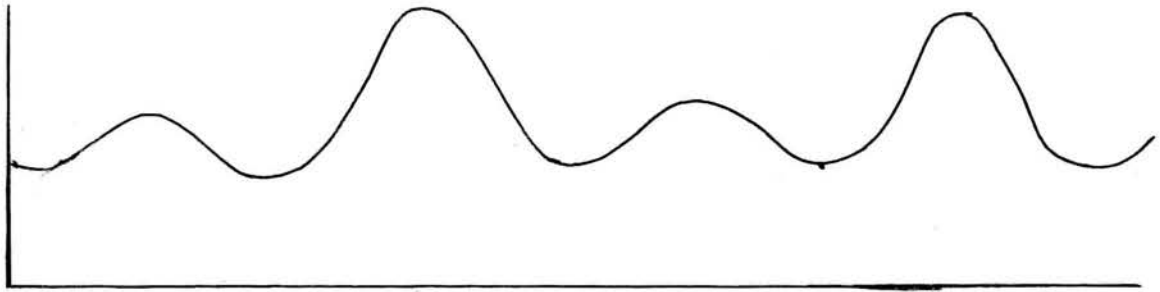

The varying of the continuous wave sent out by the oscillator is called modulation.

IV Other Uses of the Electron Tube

The Carrier Current Set.

These sets are somewhat similar to radio sets only they are connected by wires and are used in telephone and electric light service to convey high frequency from transmitter to receivers. They are used mostly for company business.

The Electric Furnace.

A small electric furnace is now being used by dentists in making up the dental alloys or metal work involved in dental work. The furnace consists of a coil through which passes a high frequency current from an electric tube. The metal to be heated is placed inside the coil and eddy currents raise the temperature of the metal to the melting point. Large electric furnaces of this type are also used where, for special reasons, a less expensive method is undesirable.

Telephone.

The three element electron tube is used extensively in long distance wire telephony. Without the use of these tubes as amplifiers or repeaters telephone service from New York to San Francisco would be ineffective.

Automatic Train Control

For many years the question of an automatic train control has been seriously considered. Accidents occur year after year when the signals were perhaps all right but the engineer failed to see them due either to negligence or bad weather conditions such as fog or storm.

One of the most promising mechanisms for automatic control employs a vacuum tube. A 60 cycle A.C. voltage is applied across the rails in insulated sections which correspond to the signal block lengths. When the locomotive enters one of these sections an E.M.F. is induced in a coil on the locomotive.

The induced current, which is very small, is then amplified by the vacuum tube and this amplified current may operate signal devices inside the cab of the locomotive or even stop the train.

Summary

I Historical

Starting with the Edison effect in 1883 the next development of the electron tube was the Fleming valve in 1904. Dr. Lee De Forest in 1907 improved the Fleming valve by adding a third element called the grid. This tube is essentially the modern electron tube.

II General Theoretical Considerations

Electron Theory

Electrons are small particles of matter having a negative charge of electricity. The movement of these particles constitutes a flow of electricity.

Thermionic Emission

When a wire is heated electrons are given off, the number depending on the temperature of the wire and also on the charge of any body which may be brought near the wire.

III Operation of the Electron Tube

The electron tube will allow current to pass through it in one direction only. This property makes it useful as a rectifier. Any small change in the electrical condition of the grid produces a great change in the current from the filament to the plate. For this reason the electron tube may be used as a detector and amplifier. In a sending set, the grid may be given a small charge by closing a battery circuit. The grid and plate voltage are coupled so that the current goes to the plate and "feeds" back to the grid and so on. These oscillations are of so called radio frequency. Vibrations from a phone diaphragm may be imposed on these oscillations. This

is called modulation.

IV Other uses of the Electron Tube.

The electron tube is also used in the carrier current set, the electric furnace, the telephone, and in automatic train control.

BIBLIOGRAPHY

College Physics by Arthur L. Kimball Ph. D.

Henry Holt & Company, November 1923. Third Edition

X Rays by C. W. C. Kaye B.A.D.Sc.

Jongmans, Green & Co. 1914

Principles of Radio Communication by J.H. Morecroft

John Wiley & Sons, Inc. 1921

Practical Wireless Telegraphy by Elmer E. Busher

Wireless Press Inc. Revised Edition

Ions, Electrons and Ionizing Radiations

by J.A. Crowther Sc.D., F. Inst. P.

Edward Arnold & Co. 1924 Fourth Edition

Practical Physics by N.H. Black, A.M. and H.N. Davis, Ph.D.

Macmillan Co. 1924 Revised Edition

The Radio Manual by Orrin E. Dunlap, Jr., B.S.

Houghton Mifflin Co. 1924

Circular of the Bureau of Standards No. 74

Washington Gov. Printing Office, 1918

High Vacuum by Saul Dushman

General Electrical Review, 1922

Scientific Papers of the Bureau of Standards.

by E. S. Purinton, Associate Physicist

No. 423 Operation of the Modulator Tube in Radio Telephone Sets. Nov. 15, 1921

No. 450. An Electron Tube Amplifier Using 60-Cycle Alternating Current To Supply Power For the Filaments and Plates.

By P. D. Lowell, Associate Physicist. Oct. 2, 1922.

No. 355. Determination of the Output.

Characteristics of Electron Tube Generators.

By Lewis M. Hull, Assistant Physicist. Dec. 1, 1919.

No. 449. Radio-Frequency Amplifiers.

By P. D. Lowell, Associate Physicist. Oct. 2, 1922.

No. 351. Dependence of the Input Impedance of a Three-Electrode Vacuum Tube Upon the Load in the Plate Circuit.

By John M. Miller, Physicist. Nov. 21, 1919.

Technologic Papers of the Bureau of Standards.

No. 256. Some Methods of Testing Radio Receiving Sets.

By J. L. Preston, Physicist. L. C. F. Horle, Consulting Radio Engineer. Mar. 26, 1924.

University of Southern California Bulletin

by August Hund, E E., D Eng.

Univ. of S. Cal. January 1916

Vacuum Tubes Lecture 44

General Electric Co.